

Dell™ PowerEdge™ Systems

Dell Oracle Database 10g R2

Enterprise Edition on

Microsoft® Windows

Server® 2003

R2 with SP2, Standard or

Enterprise x64 Edition

Deployment Guide

Version 3.1



Notes and Notices



NOTE: A NOTE indicates important information that helps you make better use of your computer.



NOTICE: A NOTICE indicates either potential damage to hardware or loss of data and tells you how to avoid the problem.

Information in this document is subject to change without notice.

© 2008 Dell Inc. All rights reserved.

Reproduction in any manner whatsoever without the written permission of Dell Inc. is strictly forbidden.

Trademarks used in this text: *Dell*, the *DELL* logo, *OpenManage*, *PowerEdge*, and *PowerVault* are trademarks of Dell Inc.; *Intel* and *Xeon* are registered trademarks of Intel Corporation; *EMC*, *Navisphere*, and *PowerPath* are registered trademarks of EMC Corporation; *Microsoft*, *Windows*, and *Windows Server* are either trademarks or registered trademarks of Microsoft Corporation in the United States and/or other countries; *AMD* and *Opteron* are trademarks of AMD Corporation.

Other trademarks and trade names may be used in this document to refer to either the entities claiming the marks and names or their products. Dell Inc. disclaims any proprietary interest in trademarks and trade names other than its own.

Contents

| | |
|---|-----------|
| Terminology Used in this Document | 7 |
| Software and Hardware Requirements | 8 |
| Minimum Software Requirements | 8 |
| Minimum Hardware Requirements. | 8 |
| Installing and Configuring the Operating System | 11 |
| Installing the Operating System Using the Deployment CD/DVDs | 11 |
| Verifying the Temporary Directory Paths. | 15 |
| Verifying Cluster Hardware and Software Configurations | 16 |
| Setting Up Your Fibre Channel Cluster | 17 |
| Before You Begin | 18 |
| Cabling Your Dell EMC Fibre Channel Storage | 19 |
| Setting Up Your SAS Cluster with a PowerVault MD3000 | 20 |
| Before You Begin | 21 |
| Cabling Your SAS Storage System | 22 |
| iSCSI Cluster Setup with a PowerVault MD3000i and MD1000 Expansion Enclosures | 23 |
| Setting Up iSCSI Cluster with PowerVault MD3000i Storage System and PowerVault MD1000 Expansion Enclosures. | 25 |
| Post Installation Tasks | 28 |

| | |
|---|-----------|
| Configuring Networking and Storage for Oracle RAC 10g R2 | 28 |
| Configuring the Public and Private Networks | 28 |
| Installing the Host-Based Software Needed for Storage | 34 |
| Verifying the Storage Assignment to the Nodes | 34 |
| Preparing the Disks for Oracle Clusterware | 36 |
| Removing the Assigned Drive Letters | 41 |
| Installing Oracle RAC 10g R2 Using OCFS | 41 |
| Installing Oracle Clusterware Version 10.2.0.1 | 42 |
| Installing Oracle Database 10g R2 with Real Application Clusters 10.2.0.1 | 45 |
| Installing Oracle 10g R2 Patchset 10.2.0.3 | 46 |
| Downloading the Latest Oracle Patches | 48 |
| Configuring the Listener | 49 |
| Creating the Seed Database | 49 |
| Installing Oracle RAC 10g R2 Using ASM | 52 |
| Installing Oracle Clusterware Version 10.2.0.1 | 52 |
| Installing Oracle10g Database With Real Application Clusters 10.2.0.1 | 54 |
| Installing Patchset 10.2.0.3 | 56 |
| Configuring the Listener | 58 |
| Creating the Seed Database | 58 |
| Adding a New Node to an Existing Oracle 10g RAC Cluster | 62 |
| Preparing the Node to be Added to a Cluster | 62 |
| Adding Nodes at the Oracle Clusterware Layer | 63 |
| Adding Nodes at the Oracle RAC Database Layer | 64 |
| Adding Database Instances to New Nodes | 65 |

| | |
|--|-----------|
| Troubleshooting | 66 |
| Working Around Clusterware Installation Failure. | 66 |
| Uninstalling Oracle Clusterware | 67 |
| Additional Troubleshooting Issues | 71 |
| Getting Help | 81 |
| Dell Support. | 81 |
| Oracle Support | 82 |
| Obtaining and Using Open Source Files | 82 |
| | |
| Index | 83 |

This document provides information for installing, configuring, reinstalling, and using your Oracle Database 10g R2 software following Dell's Supported Configurations for Oracle.

Use this document in conjunction with the *Dell Deployment* CD to install your software. If you install your operating system using only the operating system CDs, the steps in this document may not be applicable.

The following topics are covered:

- Software and hardware requirements
- Installing and configuring Microsoft® Windows Server® 2003 R2 with SP2, Standard/Enterprise x64 Edition
- Verifying cluster hardware and software configurations
- Configuring networking and storage for Oracle Database Real Application Clusters (RAC) 10g R2
- Installing Oracle Database RAC 10g R2 10.2.0.3 patchset and software updates
- Supported software stack
- Troubleshooting
- Getting help

For more information on Dell's Supported Configurations for Oracle, see the Dell and Oracle website at dell.com/10g.

If you purchased the Oracle Database RAC 10g Deployment Service, your Dell Professional Services representative will assist you with the following:

- Verifying cluster hardware and software configurations
- Configuring networking and storage
- Installing Oracle Database RAC 10g R2 10.2.0.3 patchset and software updates

Terminology Used in this Document

This document uses the terms *logical unit number* (LUN) and *virtual disk*. These terms are synonymous and can be used interchangeably. The term *LUN* is commonly used in a Dell|EMC Fibre-Channel storage system

environment and *virtual disk* is commonly used in a Direct-attached SAS (Dell MD3000/MD3000i and Dell MD3000/MD3000i with MD1000 expansion) storage environment.

Software and Hardware Requirements

The following sections describe the minimum software and hardware requirements for Dell's Supported Configurations for Oracle.

Minimum Software Requirements

Table 1-1 lists the minimum software requirements.



NOTE: Your Dell configuration includes a 30-day trial license of Oracle software. If you do not have a license for this product, contact your Dell sales representative.

Table 1-1. Software Requirements

| Software Component | Configuration |
|--|---|
| Microsoft Windows Server 2003 R2 | Standard/Enterprise x64 Editions |
| Oracle10g R2 | Version 10.2.0.1 Enterprise Edition, including the RAC option for clusters Oracle Patchset 10.2.0.3 |
| EMC® PowerPath® (Fibre Channel clusters only) | Version 5.0 |

Minimum Hardware Requirements

Table 1-2 lists the minimum hardware requirements. For more information on specific hardware components, see the documentation included with your system.



NOTE: Depending on the number of users, the application you use, your batch processes, and other factors, you may need a system that exceeds the minimum hardware requirements to achieve your desired performance.



NOTE: The hardware configuration of all the cluster nodes should be identical.

Table 1-2. Minimum Hardware Requirements - Direct-Attached SAS or Fibre Channel Cluster Configurations

| Hardware Component | Configuration |
|--|--|
| Dell PowerEdge 1950 III system (up to 8 nodes) | Intel [®] Xeon [®] processor family. 1 GB of RAM. |
| Dell PowerEdge 2900 III system (up to 8 nodes) | PowerEdge Expandable RAID Controller (PERC) for internal hard drives. |
| Dell PowerEdge 2950 III system (up to 8 nodes) | Two 73-GB hard drives connected to a PERC controller. |
| Dell PowerEdge 6850 system (up to 8 nodes) | NOTE: Dell recommends two 73-GB hard drives (RAID 1) connected to a PERC 5/i, PERC 4e/Di, or PERC 4e/Si based on your system. See your PowerEdge system documentation for more details. |
| Dell PowerEdge R900 system (up to 8 nodes) | Three Gigabit Network Interface Cards (NICs). |
| Dell PowerEdge M600 system (up to 8 nodes) | Two Host Bus Adapters (HBAs) (1 QLE2462 [dual port] HBA for use with PowerEdge 1950. 1 QME2472 or LPe1105-M4 [dual port] HBA for use with PowerEdge M600. |

Table 1-2. Minimum Hardware Requirements - Direct-Attached SAS or Fibre Channel Cluster Configurations (continued)

| Hardware Component | Configuration |
|---|---|
| Dell PowerEdge 6950 system (up to 8 nodes) | AMD Opteron™ processor family. 1 GB of RAM. |
| Dell PowerEdge 2970 system (up to 8 nodes) | PowerEdge Expandable RAID Controller (PERC) for internal hard drives. |
| Dell PowerEdge M605 system (up to 8 nodes) | Two 73-GB hard drives connected to a PERC 5/i controller. |
| Dell PowerEdge R805 system (up to 8 nodes) | NOTE: Dell recommends two 73-GB hard drives (RAID 1) connected to a PERC 5/i based on your system. See your PowerEdge system documentation for more details. |
| Dell PowerEdge R905 system (up to 8 nodes) | Three Gigabit Network Interface Cards (NICs). |
| | Two host bus adapters (HBAs) for use with PowerEdge 6950 or 2970. |
| | 1 QME2472 or LPe1105-M4 [dual port] HBA for use with PowerEdge M605. |
| Gigabit Ethernet switch (two required) | See dell.com/10g for information on supported configurations. |
| For Fibre Channel: | See the Dell EMC system documentation for more details. |
| Dell EMC CX3-10C, CX3-20, CX3-20F, CX3-40, CX3-40F, CX3-80 Fibre Channel storage system | |
| For Direct-attached SAS: | See your Dell™ PowerVault™ MD3000 and MD1000 storage system documentation for more details. |
| Dell™ PowerVault™ MD3000 with MD1000 expansion storage system. | |
| For Direct-attached or switched iSCSI: | See your Dell™ PowerVault™ MD3000i and MD1000 storage system documentation for more details. |
| Dell™ PowerVault™ MD3000i with MD1000 expansion storage system. | |

Installing and Configuring the Operating System

 **NOTICE:** To ensure that the operating system is installed correctly, disconnect all external storage from the system *before* you install the operating system.

This section provides information about installing and configuring the Windows Server 2003 SP2 Standard/Enterprise x64 Edition operating system for Oracle deployment.

 **NOTE:** If the stand-alone CD for *Windows Server 2003, SP2 Standard x64 Edition* is not yet available, then use the *Windows Server 2003, R2 Standard x64 Edition* CD during deployment and update it to SP2 using the *Windows Server 2003, SP2 (x64) ISO-9660* CD image.

Installing the Operating System Using the Deployment CD/DVDs

Repeat the steps in this section for all nodes in the cluster.

 **NOTE:** See the Dell Support website at support.dell.com for the latest BIOS, firmware, and driver updates.

- 1 Shut down your system.
- 2 Disconnect all external storage devices from your system.
- 3 Locate the correct *Microsoft Windows Server 2003 R2 Standard/Enterprise x64 Edition SP2 CD* and the *Dell Systems Management CD/DVD* for your Dell Server using the following table:

Table 1-3. PowerEdge Server Systems Management CD/DVD

| Dell PowerEdge Server | Systems Management CD/DVD |
|---|---|
| 6850, 6950 | Dell Systems Build and Update Utility CD |
| 1950, 2900, 2950, 2970 1950 III, 2900 III, 2950 III, R900 | |
| M600, M605, R805, R905 | Dell Systems Management Tools and Documentation DVD |

 **NOTE:** The Dell Systems Management CD/DVD is packaged with your Dell server.

- 4 Turn on your system.

- 5 Insert the *Dell Systems Management* CD/DVD for your system in your system drive. Refer to Table 1-3 on page 11.



NOTE: If your server does not have a CD/DVD drive, an externally attached USB CD/DVD drive can be used.

The boot menu screen appears.

- 6 In the **Select Language** screen, select **English**.
- 7 On the **Software License Agreement** page, click **Accept**.
The **Systems Build and Update Utility** home page appears.
- 8 From the **Dell Systems Build and Update Utility** home page, click **Server OS Installation**.
The **Server OS Installation** screen appears.

The Server Operating System Installation (SOI) module in the Dell™ Systems Build and Update Utility enables you to install Dell-supported operating systems on your Dell systems.



NOTE: For more information on using the specific SOI screens, see the Dell Systems Build and Update Utility online help.

The following steps will guide you through the SOI steps.

Set Date and Time:

- a Set the current date and time and the Time Zone and click **Continue**.

Select Operation System:

- b Select **Microsoft Windows Server 2003 Service Pack 2 x64 Edition**.
- c At **Create Utility Partition**, select **Yes**.
- d Click **Continue**.

Configure RAID



NOTE: This menu may not appear depending on the system

- e Choose default selections and click **Continue**.

Configure Physical disk:

- f Choose the default selections and click **Continue**.

Network Configuration:

- g Choose the default selections and click **Continue**.

 **NOTE:** To configure the public network properly, the computer name and public host name must be identical.

Enter OS Information:

- h Enter the appropriate **User Name**, **Organization**, and **Product ID**.

- i Enter all other necessary information.

- j Click **Install SNMP** (default).

 **NOTE:** If you have the *Dell OpenManage* CD and want to install it during your OS install, select **Install Server Administrator**. The Server Administrator can be installed anytime after the OS is installed.

Installation Summary:

- k Click **Eject CD/DVD Automatically** (default).

 **NOTE:** Once you click **Continue**, the installation begins and you cannot change the configuration details of your system.

- l Click **Continue**.

The Microsoft Windows Server 2003 Service Pack 2 x64 Edition Installation Wizard appears and the installation begins.

 **NOTE:** This procedure may take several minutes to complete.

- m When prompted, insert the *Windows Server 2003 Service Pack 2 x64 Edition* CD in the CD drive.

 **NOTE:** This procedure may take several minutes to complete.

 **NOTE:** If you selected **Install Server Administrator** in the OS installation steps, the prompt will ask you to insert the *Dell OpenManage™* CD prior to installing the *Windows Server 2003 Service Pack 2 x64 Edition* CD.

- n When the installation is completed, remove the CD from the CD/DVD drive and click **Finish**.

The system reboots copying the OS information to the Deployment partition and the installation continues.

 **NOTE:** This procedure may take several minutes to complete.

- 9 In the **Personalize Your Software** window in the **Name** and **Organization** fields, enter the appropriate information and click **Next**.
- 10 When prompted, enter your Product Key for Windows Server 2003 SP2 Standard/Enterprise x64 Edition and click **Next**.
- 11 In the **Computer Name** and **Administrator password** fields, enter the appropriate information and click **Next**.



NOTICE: Do not leave the administrator password blank.



NOTE: To configure the public network properly, the computer name and public host name must be identical.



NOTE: Record the logon password that you created in this step. You will need this information in step 14.

When the installation procedure is completed, the **Welcome to Windows** window appears.

- 12 Shut down the system, reconnect all external storage devices, and start the system.
- 13 In the **Welcome to Windows** window, press <Ctrl><Alt><Delete> to continue.

The **Log On** window appears.

- 14 In the **Password** field, type the administrator password that you created in step 11 in this procedure and click **OK**.

You are prompted to insert the *Windows Server* CD2. You can insert the *Windows Server* CD2 or select **Cancel**.



NOTE: If you insert the *Windows Server* CD2, follow the prompts through the normal installation process. The following process assumes you are not inserting the *Windows Server* CD2.

- 15 Select **Cancel**.

You are prompted that media on *Windows Server* CD2 is not going to be installed.

- 16 Select **OK**.

You are prompted to configure Windows Server Post-Setup (optional).

- 17 Select **Finish**.

You are prompted to close the page.

- 18 Select **Yes**.

The Manage Your Server windows management window displays.

- 19 Close the window.



NOTE: To use the Broadcom Advanced Control Suite 3 (BACS), install Microsoft .NET Framework 2.0. The Microsoft .NET Framework 2.0 can be downloaded from www.microsoft.com.

Installing of the Resource CD:

- 20 Insert the CD labeled, *Dell RCD x64 3.1*.

- 21 Go to **My Computer** and double click your CD-ROM drive.

- 22 Run `install_drivers.bat`



NOTE: This procedure may take several minutes to complete.

- 23 Press any key to continue.

- 24 Reboot your system.

- 25 Check the logs to verify that all drivers were installed correctly.



NOTE: Log information can be found at: `<Primary Drive:/>Dell_Resource_CD/logs`

- 26 When installation is completed, remove the CD from the CD drive.

Verifying the Temporary Directory Paths

Verify that the paths to the **Temp** and **Tmp** directories have been set correctly. Repeat the following steps for all nodes in the cluster.

- 1 Click **Start** and select **Run**.
- 2 In the **Open** field, type `cmd` and click **OK**.
- 3 At the command prompt, type `echo %Temp%` and press `<Enter>`.

The following path appears:

`%SystemDrive%\Temp`

where `% SystemDrive%` is the user's local drive.

- 4 At the command prompt, type `echo %Tmp%` and press <Enter>.

The following path appears:

```
%SystemDrive%\Temp
```

where `%SystemDrive%` is the user's local drive.

- 5 Repeat all steps in this section for all nodes in the cluster.

Verifying Cluster Hardware and Software Configurations

Before you begin the cluster setup, ensure that you have the minimum hardware installed as shown in Table 1-2. This section provides setup information for hardware and software cluster configurations.

Each node must have the following software installed:

- Windows Server 2003 SP2 Standard/Enterprise x64 Edition (see Table 1-1)
- HBA drivers.
- *PowerVault MD3000 or PowerVault MD3000i Resource CD* (when using the PowerVault MD3000/MD3000i as backend storage)

The storage must be configured with a minimum of four virtual disks/LUNs (two for the redundant Voting Disk and Oracle Cluster Registry and two for the database and Flash Recovery area) assigned to cluster nodes.

Table 1-4. Virtual Disk (LUN) Configuration and Sizes

| Virtual Disk/LUN | Minimum Size | Number of Partitions | Used for |
|------------------|---|------------------------------|---|
| 1 | 2 GB | 5 (3 x 50 MB and 2 x 120 MB) | Voting disk (3 x 50 MB) Oracle Registry (2 x 120 MB) |
| 2 | Larger than the database | 1 | Database |
| 3 | At least twice the size of the database | 1 | Flash Recovery Area |

Setting Up Your Fibre Channel Cluster

After a Dell Managed Services representative completes the setup of your Fibre Channel cluster, verify the hardware connections and the hardware and software configurations as described in this section. Figure 1-1, Figure 1-2, and Table 1-5 illustrate the required cluster connections for a storage area network (SAN)-attached Fibre Channel cluster with two nodes.

Figure 1-1. Hardware Connections for a SAN-attached Fibre Channel Cluster

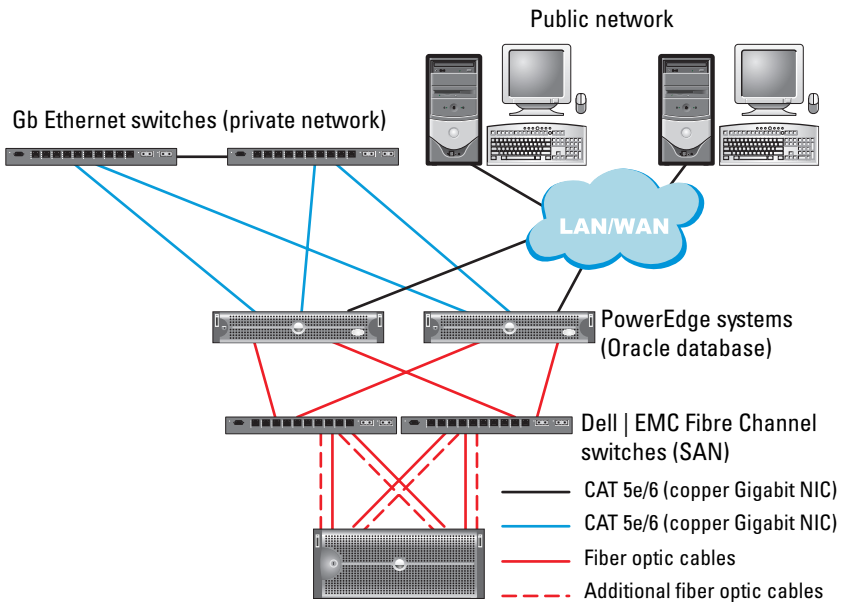

Dell | EMC CX3-10c, CX3-20, CX3-20F, CX3-40, CX3-40F or CX3-80 Fibre Channel storage systems

Table 1-5. Fibre Channel Hardware Interconnections

| Cluster Component | Connections |
|---------------------------------------|--|
| PowerEdge system node | <p>One CAT 5e/6 cable from public NIC to the local area network (LAN)</p> <p>One CAT 5e/6 cable from private Gigabit NIC to Gigabit Ethernet switch (private network)</p> <p>One CAT 5e/6 cable from redundant private Gigabit NIC to redundant Gigabit Ethernet switch (private network)</p> <p>One optical cable from optical HBA 0 to Fibre Channel switch 0 and one optical cable from HBA 1 to switch 1</p> |
| Dell EMC Fibre Channel storage system | <p>Two CAT 5e/6 cables connected to LAN (one from each storage processor)</p> <p>One to four optical connections to each Fibre Channel switch in a SAN-attached configuration</p> <p>See "Cabling Your Dell EMC Fibre Channel Storage" on page 19 for more information.</p> |
| Dell EMC Fibre Channel switch | <p>One optical connection to each PowerEdge system's HBA and one optical connection to a port on each storage processor</p> |
| Gigabit Ethernet switch | <p>One Cat 5e/6 connection to the private Gigabit NIC on each PowerEdge system</p> <p>One Cat 5e/6 connection to the other Gigabit Ethernet switch</p> |

Before You Begin

Verify that the following tasks have been completed for your cluster:

- All hardware is installed in the rack.
- All hardware interconnections are configured.
- All virtual disks/LUNs, RAID groups, and storage groups are created on the storage system.
- Storage groups are assigned to the cluster nodes.

NOTICE: Before you perform the procedures in the following sections, ensure that the system hardware and cable connections are installed correctly.

Cabling Your Dell|EMC Fibre Channel Storage

You can configure your Oracle cluster storage system in a four-port SAN-attached configuration, depending on your needs. See the following procedures for both configurations.

Figure 1-2 illustrates the hardware connections used in setting up a SAN-attached Fibre Channel cluster.

Figure 1-2. Cabling in a Dell|EMC SAN-Attached Fibre Channel Cluster

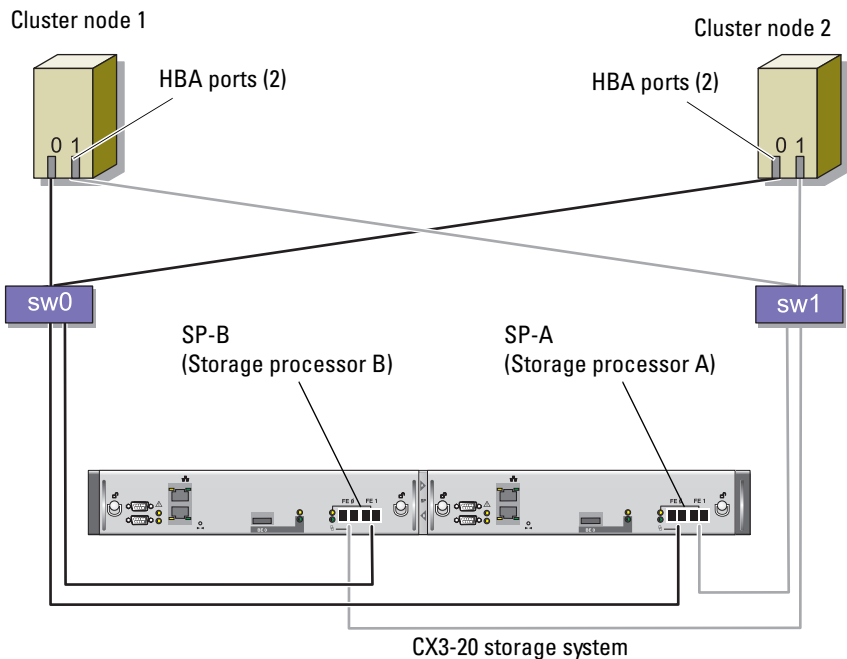

Use the following procedure to configure your Oracle cluster storage system in a four-port, SAN-attached configuration.

- 1 Connect one optical cable from SP-A port 0 to Fibre Channel switch 0.
- 2 Connect one optical cable from SP-A port 1 to Fibre Channel switch 1.

- 3 Connect one optical cable from SP-B port 0 to Fibre Channel switch 1.
- 4 Connect one optical cable from SP-B port 1 to Fibre Channel switch 0.
- 5 Connect one optical cable from HBA 0 on node 1 to Fibre Channel switch 0.
- 6 Connect one optical cable from HBA 1 on node 1 to Fibre Channel switch 1.
- 7 Connect one optical cable from HBA 0 of each additional node to Fibre Channel switch 0.
- 8 Connect one optical cable from HBA 1 of each additional node to Fibre Channel switch 1.

Setting Up Your SAS Cluster with a PowerVault MD3000

To configure your PowerEdge Systems and PowerVault MD3000 hardware and software to function in an Oracle Real Application Cluster environment, verify the following hardware connections and the hardware and software configurations as described in this section using Figure 1-3, Table 1-6, Figure 1-4 and Table 1-4.

Figure 1-3. Cabling the SAS Cluster and PowerVault MD3000

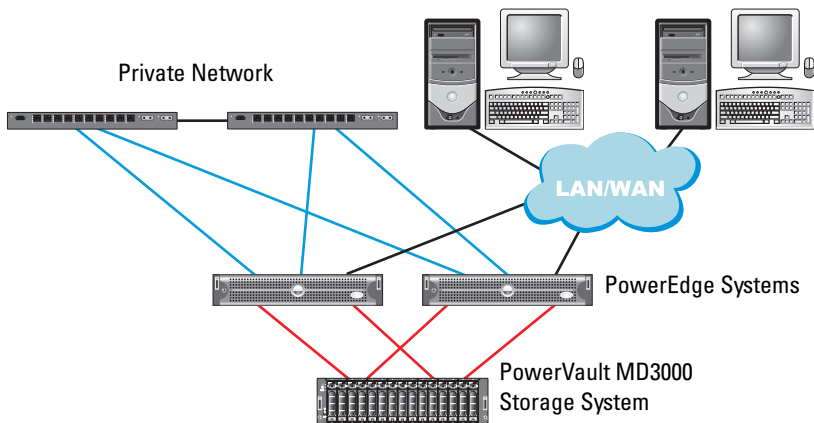

Table 1-6. SAS Cluster Hardware Interconnections

| Cluster Component | Connections |
|--------------------------|--|
| PowerEdge system node | One CAT 5e/6 cable from public NIC to the local area network (LAN) One CAT 5e/6 cable from private Gigabit NIC to Gigabit Ethernet switch (private network) One CAT 5e/6 cable from redundant private Gigabit NIC to redundant Gigabit Ethernet switch (private network) Two SAS connections to a PowerVault MD3000 storage system node using a SAS 5/E. See "Cabling Your SAS Storage System" on page 22 |
| Dell PowerVault MD3000 | Two CAT 5e/6 cables connected to a LAN (one from each storage processor module) Two SAS connections to each PowerEdge system node using a SAS 5/E controller. See "Cabling Your SAS Storage System" on page 22 |
| Gigabit Ethernet switch | One Cat 5e/6 connection to the private Gigabit NIC on each PowerEdge system One Cat 5e/6 connection to the other Gigabit Ethernet switch |

Before You Begin

Verify that the following tasks have been completed for your cluster:

- All hardware is installed in the rack.
- All hardware interconnections are configured.
- All virtual disks/LUNs, RAID groups, and storage groups are created on the storage system.
- Storage groups are assigned to the cluster nodes.



NOTICE: Before you perform the procedures in the following sections, ensure that the system hardware and cable connections are installed correctly.

Cabling Your SAS Storage System

Because SAS clusters can only be installed in a direct-attached cluster, they are limited to two nodes only.

To configure your nodes in a direct-attached configuration (see Figure 1-4), complete the following steps:

- 1** Connect one SAS cable from a port of the SAS controller of node 1 to the In-0 port of RAID controller 0 in the MD3000 RAID enclosure.
- 2** Connect one SAS cable from a port of the other SAS controller of node 1 to the In-0 port of RAID controller 1 in the MD3000 RAID enclosure.
- 3** Connect one SAS cable from a port of the SAS controller of node 2 to the In-1 port of RAID controller 0 in the MD3000 RAID enclosure.
- 4** Connect one SAS cable from a port of the other SAS controller of node 2 to the In-1 port of RAID controller 1 in the MD3000 RAID enclosure.

Figure 1-4. Cabling in a Direct-attached SAS Cluster

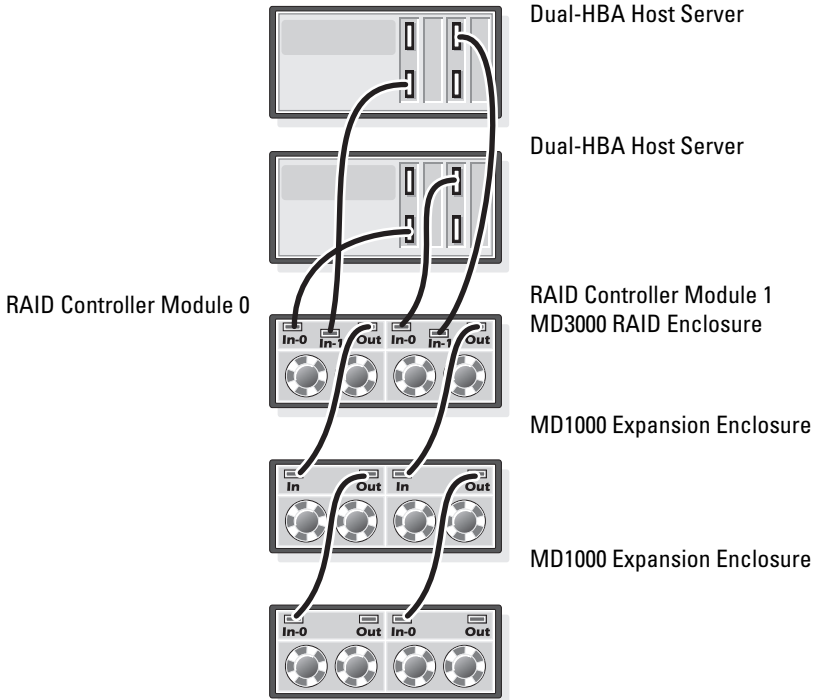

iSCSI Cluster Setup with a PowerVault MD3000i and MD1000 Expansion Enclosures

This section provides information and procedures to configure your PowerEdge Systems and PowerVault MD3000i hardware and software to function in a Oracle Real Application Cluster environment.

Verify the hardware connections, and the hardware and software configurations, using the "Supported Configuration" figures contained in the *Dell PowerVault MD3000i Support Matrix*. The documentation can be downloaded from support.dell.com.

Table 1-7. iSCSI Hardware Interconnections

| Cluster Component | Connections |
|--|--|
| Each PowerEdge system node | <p>One CAT 5e/6 cable from public NIC to the local area network (LAN)</p> <p>One CAT 5e/6 cable from private Gigabit NIC to Gigabit Ethernet switch (private network)</p> <p>One CAT 5e/6 cable from redundant private Gigabit NIC to redundant Gigabit Ethernet switch (private network)</p> <p>For additional information on the MD3000i see your PowerVault MD3000i set-up documentation.</p> |
| Each Dell PowerVault MD3000i storage system | <p>Two CAT 5e/6 cables connected to LAN (one from each storage processor module) for the management interface.</p> <p>Two CAT 5e/6 cables per storage processor for iSCSI interconnect.</p> <p>For additional information on the MD3000i see your PowerVault MD3000i set-up documentation.</p> |
| Each Dell PowerVault MD1000 storage expansion enclosure (optional) | <p>Additional SAS cable connections as required for the MD1000 expansion enclosures.</p> |

Setting Up iSCSI Cluster with PowerVault MD3000i Storage System and PowerVault MD1000 Expansion Enclosures

Task 1: Hardware Setup

Direct-attached iSCSI clusters are limited to two nodes only.

Figure 1-5. Cabling iSCSI Direct-Attached Clusters

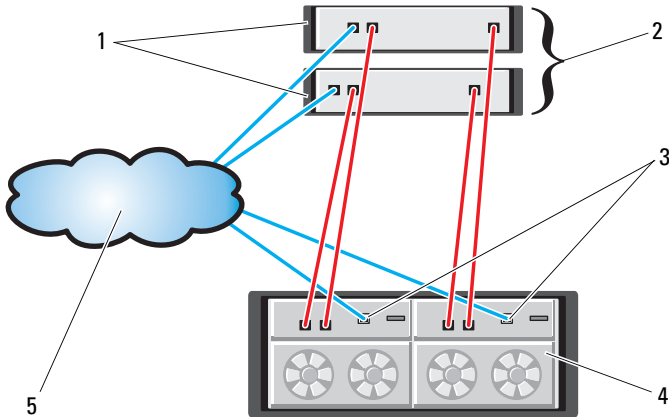

- | | | | |
|---|--------------------------------------|---|--|
| 1 | standalone (one or two) host server | 2 | two-node cluster server |
| 3 | Ethernet management port (2) | 4 | MD3000i RAID Enclosure (dual controller) |
| 5 | corporate, public or private network | | |

To configure your nodes in a direct-attached configuration see Figure 1-5, and complete the following steps:

- 1 Connect one CAT 5e/6 cable from a port (iSCSI HBA or NIC) of node 1 to the In-0 port of RAID controller 0 in the MD3000i storage enclosure.
- 2 Connect one CAT 5e/6 cable from the other port (iSCSI HBA or NIC) of node 1 to the In-0 port of RAID controller 1 in the MD3000i storage enclosure.

- 3 Connect one CAT 5e/6 cable from a port (iSCSI HBA or NIC) of node 2 to the In-1 port of RAID controller 0 in the MD3000i storage enclosure.
- 4 Connect one CAT 5e/6 cable from the other port (iSCSI HBA or NIC) of node 2 to the In-1 port of RAID controller 1 in the MD3000i storage enclosure.
- 5 (Optional). Connect two SAS cables from the two MD3000 out ports to the two In ports of the first MD1000 expansion enclosure.
- 6 (Optional). Connect two SAS cables from the two MD1000 out ports to the In-0 ports of the second MD1000 expansion enclosure.

NOTE: Refer to the MD3000i storage system documentation for information on configuring the MD1000 expansion enclosures.

Switched iSCSI clusters can support up to eight nodes.

Figure 1-6. Cabling iSCSI Switched Clusters

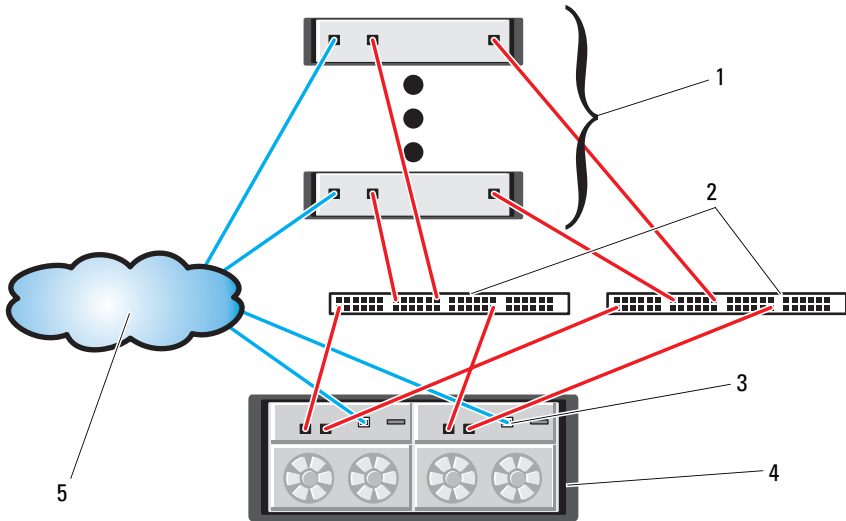

- | | | | |
|---|----------------------------------|---|--|
| 1 | up to 16 standalone host servers | 2 | IP SAN (dual Gigabit Ethernet switches) |
| 3 | Ethernet management port (2) | 4 | MD3000i RAID Enclosure (dual controller) |

5 corporate, public or private network

To configure your nodes in a switched configuration see Figure 1-6, and complete the following steps:

- 1 Connect one CAT 5e/6 cable from a port (iSCSI HBA or NIC) of node 1 to the port of network switch 1.
- 2 Connect one CAT 5e/6 cable from a port (iSCSI HBA or NIC) of node 1 to the port of network switch 2.
- 3 Connect one CAT 5e/6 cable from a port (iSCSI HBA or NIC) of node 2 to the port of network switch 1.
- 4 Connect one CAT 5e/6 cable from a port (iSCSI HBA or NIC) of node 2 to the port of network switch 2.
- 5 Connect one CAT 5e/6 cable from a port of switch 1 to the In-0 port of RAID controller 0 in the MD3000i storage enclosure.
- 6 Connect one CAT 5e/6 cable from the other port of switch 1 to the In-0 port of RAID controller 1 in the MD3000i storage enclosure.
- 7 Connect one CAT 5e/6 cable from a port of switch 2 to the In-1 port of RAID controller 0 in the MD3000i storage enclosure.
- 8 Connect one CAT 5e/6 cable from the other port of switch 2 to the In-1 port of RAID controller 1 in the MD3000i storage enclosure.
- 9 (Optional). Connect two SAS cables from the two MD3000i out ports to the two In ports of the first MD1000 expansion enclosure.
- 10 (Optional). Connect two SAS cables from the two MD1000 out ports to the In-0 ports of the second MD1000 expansion enclosure.



NOTE: Refer to the MD3000i storage system documentation for information on configuring the MD1000 expansion enclosures.

Task 2: Installing the Host-based Software Needed for Storage

To install the necessary host-based storage software for the PowerVault MD3000i storage system, use the Dell PowerVault Resource CD software that came with your MD3000i storage system. Follow the procedures in your Dell documentation that is included with the PowerVault MD3000i storage system to install the "Modular Disk Storage Manager Software" on the Master node and the Multi-Path (MPIO) software on the remaining nodes.

The Microsoft iSCSI Software Initiator is required for a MD3000i storage subsystem. The Microsoft iSCSI Software Initiator can be downloaded from www.microsoft.com.

Task 3: Verifying and Upgrading the Firmware

- Discover the host server's direct-attached storage using the Modular Disk Storage Manager software that is installed on the host server.
- Verify that the firmware for the following storage components is at the minimum required version. Refer to the Solutions Deliverable List (SDL) for the firmware version requirements.
 - MD3000i storage system firmware
 - MD1000 expansion enclosure firmware

Post Installation Tasks

After installing the drivers and the software, perform the post installation tasks listed in the *MD3000i Installation Guide* to create the environment shown in Table 1-7 on page 24.

Configuring Networking and Storage for Oracle RAC 10g R2

This section provides information about network and storage configuration.

- Configuring the public and private networks.
- Verifying the storage configuration.
- Configuring the shared storage for Oracle Clusterware and the Oracle Database.



NOTE: Oracle RAC 10g R2 is a complex database configuration that requires an ordered list of procedures. To configure networking and storage in a minimal amount of time, perform the following procedures in order.

Configuring the Public and Private Networks



NOTE: Each node requires a unique public and private internet protocol (IP) address and an additional public IP address to serve as the virtual IP address for the client connections and connection failover. The virtual IP address must belong to the same subnet as the public IP address. All public IP addresses, including the

virtual IP address, should be registered with the domain naming system (DNS). If a DNS server is not available, IP addresses have to be registered in the hosts file on all cluster nodes.

Depending on the number of NIC ports available, configure the public and private interfaces as shown in Table 1-8.

Table 1-8. NIC Port Assignments

| NIC Port | Three Ports Available | Four Ports Available |
|----------|--------------------------|-----------------------|
| 1 | Public IP and virtual IP | Public IP |
| 2 | Private IP (NIC team) | Private IP (NIC team) |
| 3 | Private IP (NIC team) | Private IP (NIC team) |
| 4 | NA | Virtual IP |

Configuring and Teaming the Private Network

Before you deploy the cluster, assign a private IP address and host name to each cluster node. This procedure ensures that the nodes can communicate with each other through the private interface.

Table 1-9 provides an example of a network configuration for a two-node cluster.



NOTE: This example assumes all the IP addresses are registered in the hosts file of all cluster nodes.



NOTE: The two bonded NIC ports for a private network should be on separate PCI buses. For example, a bonded pair can consist of one on-board NIC and one add-on NIC card.

Table 1-9. Network Configuration Example for a Two-Node Cluster

| Host Name | Type | IP Address | Registered In |
|-----------|---------|----------------|---|
| rac1 | Public | 155.16.170.1 | %SystemRoot%\system32\drivers\etc\hosts |
| rac2 | Public | 155.16.170.2 | %SystemRoot%\system32\drivers\etc\hosts |
| rac1-vip | Virtual | 155.16.170.201 | %SystemRoot%\system32\drivers\etc\hosts |
| rac2-vip | Virtual | 155.16.170.202 | %SystemRoot%\system32\drivers\etc\hosts |
| rac1-priv | Private | 10.10.10.1 | %SystemRoot%\system32\drivers\etc\hosts |
| rac2-priv | Private | 10.10.10.2 | %SystemRoot%\system32\drivers\etc\hosts |

Configuring NIC Teaming For Your Private Network Adapters



NOTE: TCP Offload Engine (TOE) functionality of a TOE-capable NIC is not supported in this solution.

- 1 On node 1, identify two network adapters that will be used for NIC teaming.
- 2 Connect an Ethernet cable from each selected network adapter to the private network switch.
- 3 If node 1 is configured with Broadcom NICs, go to step 4. If node 1 is configured with Intel NICs, configure NIC teaming by performing the following steps:
 - a Right-click **My Computer** and select **Manage**.
 - b In the **Computer Management** window, select **Device Manager**.
 - c Expand the **Network Adapters** tab.
 - d Right-click the **Intel NIC**, which is identified for NIC teaming and select **Properties**.
 - e Click the **Teaming** tab.
 - f Select **Team with other Adapters** and then select **New Team**.
 - g Specify a name for NIC team and click **Next**.
 - h In the **Select the adapters to include in this team** box, select the remaining network adapters that you identified for NIC teaming and click **Next**.
 - i In the **Select a team mode** list box, select **Adaptive Load Balancing**.
 - j Click **Finish** to complete the teaming.
 - k In the **Team Properties** window, click **OK**.
 - l In the **Intel NIC's Properties** window, click **OK**.
 - m Close the **Computer Management** window.
- 4 If node 1 is configured with Broadcom NICs, configure NIC teaming by performing the following steps. If not go to step 5.
 - a Click **Start** → **Programs** → **Broadcom** → **Broadcom Advanced Control Suite 3**
The **Broadcom Advanced Control Suite 3** window appears.

- b** Highlight **Team Management**, and click **Teams** and select **Create a Team**.

The **Broadcom Teaming Wizard** window appears.

- c** Click **Next**.
- d** In the **Enter the name for the team** field, type **Private** and click **Next**.
- e** In the **Team Type** field, select **Smart Load Balancing (TM)** and **Failover (SLB)** and click **Next**.
- f** In the **Assigning Team Members** window, in the **Available Adapters** box, select the network adapters you identified for NIC teaming and add them to the **Team Members** box.



NOTE: In case of PowerEdge 6850 systems, when configuring integrated Broadcom NICs into a team, the following warning message will be displayed:

Including this adapter in a team will disrupt the system management features. Click **Yes** to proceed.

- g** Click **Next**.
 - h** In the **Designating Standby Member** window, select **Do not configure a Standby Member** and click **Next**.
 - i** In the **Configuring Live Link** window, select **No** and click **Next**.
 - j** In the **Creating/Modifying a VLAN** window, select **Skip Manage VLAN** and click **Next**.
 - k** In the last window, click **Preview** to verify the NIC team and the adapters. Once verified, select **Commit changes to system** and exit the wizard. Click **Finish**.
 - l** In the information message window click **Yes** to proceed.
 - m** In the **Broadcom Advanced Control Suite 3** window, click **File** then **Exit**.
- 5** Repeat step 1 through step 4 on the remaining nodes.

Configuring the IP Addresses for Your Public and Private Network Adapters

 **NOTE:** The TOE functionality of TOE-capable NIC is not supported in this solution.

1 Update the adapter's network interface name, if required. Otherwise, go to step 3.

a On node 1, click **Start** and navigate to **Settings**→ **Control Panel**→ **Network Connections**.

b In the **Network Connections** window, right-click the public network adapter you want to rename, and select **Rename**.

 **NOTE:** When you configure your network adapters on the cluster nodes, use identical names for the public adapters and the private adapters on all cluster nodes. Otherwise, the Oracle database installer generates an error and prevents you from completing the installation procedure.

c Rename the public adapter name to **Public** and press <Enter>.

d Right-click the Private NIC team you want to rename and select **Rename**.

e Rename the Private NIC team to **Private** and press <Enter>.

2 Configure the IP addresses.

 **NOTE:** You must set a default gateway for your public interface, otherwise, the Clusterware installation may fail.

a Click **Start**→ **Settings**→ **Control Panel**→ **Network Connections**→ **Public**→ **Properties**.

b Double-click **Internet Protocol (TCP/IP)**.

c Click **Use the following IP address**, enter the required IP address, default gateway address and the DNS server IP address, and click **OK**.

d In the **Public Properties** window, select **Show icon in notification area when connected**.

The network adapter status will appear in the system tray after you perform the procedures in this section.

e Click **OK**.

f In the **Properties** window, click **Close**.

g Repeat step a through step f on the Private NIC team.



NOTE: Private NIC team does not require a default gateway address and DNS server entry.

3 Ensure that the public and private network adapters appear in the appropriate order for access by network services.

a On the Windows desktop, click **Start**→ **Settings**→ **Control Panel**→ **Network Connections**.

b In the **Network Connections** window, click **Advanced** and select **Advanced Settings**.

c Select the **Adapter and Bindings** tab.

d Ensure that the network adapters are listed in the following order:

Public

Private

<Any other network adapter>



NOTE: Click the up- and down-arrow keys to change the adapter order.

e Click **OK**.

f Close the **Network Connections** window.

4 On all nodes, add the public, private, and virtual IP addresses and host name to the `%SystemRoot%\system32\drivers\etc\hosts` file.



NOTE: Add the public and virtual IP addresses to the hosts file only if they are not registered with the DNS server.

For example, the following entries use the adapter IP and host name as shown in Table 1-9:

IP AddressNode Name

155.16.170.1rac1

155.16.170.2rac2

10.10.10.1rac1-priv

10.10.10.2rac2-priv

155.16.170.201rac1-vip

155.16.170.202rac2-vip



NOTE: Registering the private IP addresses with the DNS server is not required because the private network IP addresses are not accessible from the public network.

- 5 Repeat step 1 through step 4 on the remaining nodes.
- 6 Ensure that the cluster nodes can communicate with the public and private networks.
 - a On node 1, open a command prompt window.

- b At the command prompt, type:

```
ping <public_host_name>
```

```
ping <private_host_name>
```

where <public_host_name> and <private_host_name> are the host names for the public and private network adapters in the remaining node.

If the node's network adapters do not respond to ping commands, check your network configuration and then repeat this step.



NOTE: Virtual internet protocol (VIP) is configured later and cannot be pinged at this point.

- c Repeat step a through step b on the remaining nodes.

Installing the Host-Based Software Needed for Storage

To install the EMC Navigent software using the EMC software that came with your Dell|EMC system, follow the procedures in your Dell|EMC documentation.

To install the necessary host-based storage software for the PowerVault MD3000 storage system, use the *Dell PowerVault Resource* CD software that came with your MD3000 storage system. Follow the procedures in your Dell documentation that is included with the PowerVault MD3000 storage system to install the "Modular Disk Storage Manager Software" on the Master node and the Multi-Path (MPIO) software on the remaining nodes.

Verifying the Storage Assignment to the Nodes

- 1 On the Windows desktop, right-click **My Computer** and select **Manage**.
- 2 In the **Computer Management** window, click **Device Manager**.

- 3 Expand **Disk drives**.
- 4 Under **Disk drives**, ensure that four small computer system interface (SCSI) disk devices appear for each LUN/virtual disk assigned in the storage.
- 5 Expand **Storage** and click **Disk Management**.

If the **Welcome to the Initialize and Convert Disk Wizard** appears, perform step a through step d. Otherwise, go to step 6.

 - a In the **Welcome to the Initialize and Convert Disk Wizard** window, click **Next**.
 - b In the **Select Disks to Initialize** window, in the **Disks** window, select the disks that are associated with your storage LUNs/virtual disks and click **Next**.
 - c In the **Select Disks to Convert** window, deselect the disk(s) that you selected in step b and click **Next**.

 **NOTE:** This procedure ensures that your disks are configured as **Basic** disks.

 - d Click **Finish**.
- 6 In the **Disk Management** window, verify that four disks appear. The disks should be similar in size to each other and to the LUNs/virtual disks that are assigned to the nodes in the storage system.
- 7 Repeat step 1 through step 6 on the remaining nodes.

Installing Multi-Path Software for Storage

Follow the documentation accompanying the storage device to install the appropriate multi-path software.

-  **NOTE:** In the case of a SAS or iSCSI (MD3000/MD3000i storage system) cluster, the Multi-Path software should already be installed on your hosts as instructed in the section "Installing the Host-Based Software Needed for Storage" on page 34

Installing PowerPath for Dell|EMC Systems

- 1 On node 1, install EMC® PowerPath®.

 **NOTE:** For more information, see the EMC PowerPath documentation that came with your Dell|EMC storage system.

- 2 When the installation procedure is completed, restart your system.
- 3 Repeat step 1 and step 2 on the remaining nodes.

Installing Multi-Path driver software for MD3000/MD3000i

- 1 On node 1, install Multi-Path driver software from the *PowerVault MD3000 or MD3000i Resource CD*.
-  **NOTE:** For more information, see the documentation that came with your Dell MD3000 or MD3000i storage system.
- 2 When the installation procedure is completed, restart your system.
- 3 Repeat step 1 and step 2 on the other node.

Verifying Multi-Path Driver Functionality

- 1 Right-click **My Computer** and select **Manage**.
- 2 Expand **Storage** and click **Disk Management**.
One disk appears for each LUN assigned in the storage.
- 3 Ensure that each LUN is configured as a **Basic** disk.
- 4 Repeat step 1 through step 3 on the remaining nodes.

Preparing the Disks for Oracle Clusterware

This section provides information for creating the logical drives for the following disks:

- Oracle Cluster Registry disk (OCR)— Contains the cluster configuration information
- Voting disk — Provides arbitration between the cluster nodes when the private network or attached storage is unavailable to one or more nodes
- Data and backup disks — Provide storage areas for creating the database (data disk) and saving the backup and log data (backup disk)

During the cluster configuration described in this document, you will create partitions on your shared storage. When you create the partitions, ensure that the cluster nodes can detect the LUNs or logical disks that are created in the attached storage system.

To prepare the disks for Oracle Clusterware, identify the OCR, voting, data and flash recovery area disks. After you identify the appropriate disks, perform the following steps on node 1.

Enabling the Automount Option for the Shared Disks

- 1 On node 1, click **Start** and select **Run**.
- 2 In the **Run** field, type **cmd** and click **OK**.
- 3 At the command prompt, type **diskpart** and press <Enter>.
- 4 At the **DISKPART** command prompt, type **automount enable** and press <Enter>.

The following message appears:

```
Automatic mounting of new volumes enabled.
```

- 5 At the **DISKPART** command prompt, type **exit** and press <Enter>.
- 6 Close the command prompt.
- 7 Repeat step 1 through step 6 on each of the remaining nodes.

Preparing the OCR and Voting Disks for Clusterware

- 1 On the Windows desktop, right-click **My Computer** and select **Manage**.
- 2 Expand **Storage** and click **Disk Management**.
The storage disk that you initialized in the "Verifying Multi-Path Driver Functionality" on page 36 appears as **Unallocated**.
- 3 Right-click the partition area of the first shared disks assigned to the cluster nodes and select **New Partition**.

The **Welcome to the New Partition Wizard** appears.

- 4 Click **Next**.
- 5 In the **Select Partition Type** window, select **Extended partition** and click **Next**.
- 6 In the **Specify Partition Size** window, accept the default partition size and click **Next**.
- 7 Click **Finish**.

The disk partition area you selected in step 3 is configured as an extended partition.

- 8 Repeat step 3 through step 7 on all shared disks that are assigned to the cluster nodes.

- 9** Create a logical drive for the OCR disk.
 - a** On the partition area of the disk identified for OCR and voting disk (1 GB LUN/virtual disk), right-click the free space and select **New Logical Drive**.

The **Welcome to the New Partition Wizard** appears.
 - b** Click **Next**.
 - c** In the **Select Partition Type** window, select **Logical drive** and click **Next**.
 - d** In the **Specify Partition Size** window, type **120** in the **Partition size in MB** field and click **Next**.
 - e** In the **Assign Drive Letter or Path** window, select **Do not assign a drive letter or drive path** and click **Next**.
 - f** In the **Format Partition** window, select **Do not format this partition** and click **Next**.
 - g** Click **Finish**.
 - h** Repeat steps a through g to create an additional OCR disk.
- 10** Create a logical drive for the Voting Disk.
 - a** On the partition area of the disk identified for the OCR and voting disk (1 GB LUN/virtual disk), right-click the free space and select **New Logical Drive**.

The **Welcome to the New Partition Wizard** appears.
 - b** Click **Next**.
 - c** In the **Select Partition Type** window, select **Logical drive** and click **Next**.
 - d** In the **Specify Partition Size** window, in the **Partition size in MB** field, type **50** and click **Next**.
 - e** In the **Assign Drive Letter or Path** window, select **Do not assign a drive letter or drive path** and click **Next**.
 - f** In the **Format Partition** window, select **Do not format this partition** and click **Next**.
 - g** Click **Finish**.

- h Repeat steps a through g two times to create two additional voting disk partitions.



NOTE: If you are using Redundant Voting Disk and OCR, repeat the steps outlined in step 9 and step 10 for the redundant Voting Disk and OCR.

Preparing the Database Disk and Flash Recovery Area for Database Storage With OCFS

This section provides information for creating logical drives that will be used to create the Oracle's Clustered File System (OCFS) storage disk.



NOTE: When using ASM storage management, the ASM data disk group should be larger than your database (multiple LUNs) and the ASM Flash Recovery Area disk group should be at least twice the size of your data disk group.



NOTE: If you are creating the logical drives that are used to create the Automatic Storage Management (ASM) storage disk, ignore the following steps and see "Preparing the Database Disk and Flash Recovery Area for Database Storage With ASM" on page 40.

- 1 On node 1, create one logical drive for the Database.
 - a Locate the disk that is assigned for the Oracle Database.
 - b On the disk partition area, right-click the free space and select **New Logical Drive**.

The **Welcome to the New Partition Wizard** appears.
 - c Click **Next**.
 - d In the **Select Partition Type** window, select **Logical drive** and click **Next**.
 - e In the **Specify Partition Size** window in the **Partition size in MB** field, type the appropriate size and click **Next**.
 - f In the **Assign Drive Letter or Path** window, select **Do not assign a drive letter or drive path** and click **Next**.
 - g In the **Format Partition** window, select **Do not format this partition** and click **Next**.
 - h Click **Finish**.

- 2 On node 1, create one logical drive for the Flash Recovery Area.
 - a Locate the disk that is assigned for the Flash Recovery Area.
 - b Perform step b through step h in step 1.
- 3 Restart all other nodes and login as the administrator.

Preparing the Database Disk and Flash Recovery Area for Database Storage With ASM

This section provides information about creating logical drives that will be used to create ASM disk storage. ASM disk storage consists of one or more disk groups that can span multiple disks.



NOTE: If you are creating the logical drives that are used to create the OCFS storage disk, ignore the following steps and follow the procedures in "Preparing the Database Disk and Flash Recovery Area for Database Storage With OCFS" on page 39

- 1 Create one logical drive for the Database.
 - a Locate the disk that is assigned for the Oracle database.
 - b On the disk partition area, right-click the free space and select **New Logical Drive**.

The **Welcome to the New Partition Wizard** appears.
 - c Click **Next**.
 - d In the **Select Partition Type** window, select **Logical drive** and click **Next**.
 - e In the **Specify Partition Size** window, type the appropriate size in the **Partition size in MB** field and click **Next**.
 - f In the **Assign Drive Letter or Path** window, select **Do not assign a drive letter or drive path** and click **Next**.
 - g In the **Format Partition** window, select **Do not format this partition** and click **Next**.
 - h Click **Finish**.
- 2 Create one logical drive for the Flash Recovery Area.
 - a Locate the disk that is assigned for the Flash Recovery Area.
 - b Perform step b through step h in step 1.
- 3 Restart all other nodes and log in as the administrator.

Removing the Assigned Drive Letters

- 1 On the Windows desktop for each node, right-click **My Computer** and select **Manage**.
- 2 In the **Computer Management** window, expand **Storage** and click **Disk Management**.
- 3 If you find any drive letters assigned to the drives that you created in "Preparing the OCR and Voting Disks for Clusterware" on page 37, perform the following steps:
 - a Right-click the logical drive and select **Change Drive Letter and Paths**.
 - b In the **Change Drive Letter and Paths** window, select the drive letter and click **Remove**.
 - c In the **Confirm** window, click **Yes**.
 - d Repeat step a through step c for the remaining logical drives on the storage partition.

Installing Oracle RAC 10g R2 Using OCFS



NOTE: If you are installing Oracle using ASM, ignore the following steps and follow the procedures in "Installing Oracle RAC 10g R2 Using ASM" on page 52

This section provides information about installing the Oracle RAC 10g R2 software. The following topics are covered:

- Installing Oracle Clusterware Version 10.2.0.1
- Installing Oracle Database 10g R2 with Real Application Clusters 10.2.0.1
- Installing 10.2.0.3 Patchset
- Configuring the Listener
- Creating the Seed Database

Installing Oracle Clusterware Version 10.2.0.1

- 1 On node 1, insert the *Oracle Clusterware 10g Release 2 for Microsoft Windows* CD into the CD drive.

The **Oracle Clusterware - Autorun** window displays. If the **Oracle Clusterware - Autorun** window does not appear:

- a Click **Start** and select **Run**.
- b In the **Run** field, type the following and click **OK**:
`%CD-ROM drive%:\autorun\autorun.exe`

where `%CD-ROM drive%` is the drive letter of your CD drive.

- 2 In the **Oracle Clusterware - Autorun** window, click **Install/Deinstall Products**. This will start the Oracle Universal Installer (OUI) and the **Welcome** screen appears.
- 3 Click **Next**.
- 4 In the **Specify Home Details** window, accept the default settings and click **Next**.

 **NOTE:** Record the OraCR10g_home (CRS Home) path because you will need this information later.

- 5 In the **Product Specification Prerequisite Checks** window, make sure all the checks are completed successfully and then click **Next**.
- 6 In the **Specify Cluster Configuration** window, enter the following:
 - An alternate cluster name (if desired).
 - The public and private network host names for both cluster nodes. Click **Add** to specify additional nodes.
 - In the **Add a new node to the existing cluster** window, enter the public, private and virtual host name, and click **OK**.

 **NOTE:** Ensure that the network host names do not include a domain name extension.

- 7 Click **Next**.

The **Specify Network Interface Usage** window appears, displaying a list of cluster-wide network interfaces.

- 8** If required, change the public **Interface Type** to **Public** (if shown as **Private**) by performing the following steps:
 - a** Select the **Interface Name** and click **Edit**.
 - b** Select the correct interface and click **OK**.
- 9** In the **Specify Network Interface Usage** window, click **Next**.
- 10** In the **Cluster Configuration Storage** window, perform the following steps for the OCR disk:
 - a** Locate the two 120 MB partitions created in the procedure "Preparing the OCR and Voting Disks for Clusterware" on page 37
 - b** Select the first partition and click **Edit**.
 - c** In the **Specify Disk Configuration** window, select **Place OCR (Primary)** on this partition and click **OK**.
 - d** Select the second partition and click **Edit**.
 - e** In the **Specify Disk Configuration** window, select **Place OCR (Mirror)** on this partition and click **OK**.
- 11** In the **Cluster Configuration Storage** window, perform the following steps for the voting disk:
 - a** Locate the three 50 MB partitions created in the procedure "Preparing the OCR and Voting Disks for Clusterware" on page 37.
 - b** Select the first partition and click **Edit**.
 - c** In the **Specify Disk Configuration** window, select **Place Voting Disk on this partition** and click **OK**.
 - d** Repeat steps b and c on the remaining Voting Disk partitions.
- 12** In the **Cluster Configuration Storage** window, perform the following steps for the database:
 - a** Locate the partition created in step 1 of "Preparing the Database Disk and Flash Recovery Area for Database Storage With OCFS" on page 39.
 - b** Select the partition and click **Edit**.
 - c** In the **Specify Disk Configuration** window, select **Format partition with CFS**.
 - d** Ensure that the **Use partition for data storage** is selected.

- e Use the pull-down menu of the **Assign Drive Letter** option to assign a drive letter to the partition.
 - f Click **OK**.
- 13** In the **Cluster Configuration Storage** window, perform the following steps for flash recovery:
- a Locate the partition created in step 2 of "Preparing the Database Disk and Flash Recovery Area for Database Storage With OCFS" on page 39
 - b Select the partition and click **Edit**.
 - c In the **Specify Disk Configuration** window, select **Format partition with CFS**.
 - d Ensure that **Use partition for data storage** is selected.
 - e Use the pull-down menu of the **Assign Drive Letter** option to assign a drive letter to the partition.
 - f Click **OK**.
- 14** In the **Cluster Configuration Storage** window, click **Next**.
- 15** Ignore the warning messages and click **OK**.
- 16** In the **Summary** window, click **Install** to start the installation procedure. The **Install** window appears, displaying an installation progression bar. The **Configuration Assistant** window appears and the OUI runs a series of configuration tools. The **End of Installation** window appears.
-  **NOTE:** If a failure occurs in the **Configuration Assistant** window, perform the following steps and see "Troubleshooting" on page 66 and "Working Around Clusterware Installation Failure" on page 66.
- a In the error window, click **OK**.
 - b In the **Configuration Assistant** window, click **Next**.
 - c Ignore the warning message and click **OK**.
 - d Click **Exit** to finish the OUI session.
 - e In the **Exit** window, click **Yes**.

- 17 If you are installing Oracle using ASM, go to "Installing Oracle RAC 10g R2 Using ASM" on page 52; otherwise, continue to "Installing Oracle RAC 10g R2 Using OCFS."

Installing Oracle Database 10g R2 with Real Application Clusters

10.2.0.1

- 1 On node 1, insert the *Oracle Database 10g Release 2 for Microsoft Windows* CD into the CD drive.

The **Oracle Database 10g - Autorun** window displays. If the **Oracle Database 10g - Autorun** window does not appear:

- a Click **Start** and select **Run**.
- b In the **Run** field, type the following and click **OK**:

```
%CD-ROM drive%:\autorun\autorun.exe
```

where *%CD-ROM drive%* is the drive letter of your CD drive.

- 2 In the **Oracle Database 10g - Autorun** window, click **Install/Deinstall Products**. This will start the OUI and the **Welcome** screen appears.
- 3 Click **Next**.
- 4 In the **Select Installation Type** window, select **Enterprise Edition** and click **Next**.
- 5 In the **Specify Home Details** window under **Destination**, verify the following:

- In the **Name** field, the Oracle database home name is `OraDb10g_home1`.
- In the **Path** field, the complete Oracle home path is

```
%SystemDrive%\oracle\product\10.2.0\db_1
```

 where *%SystemDrive%* is the user's local drive.

By default OUI chooses one of CFS shared drive for copying the database files. Change the drive to the *%SystemDrive%* by changing the drive letter in the **Path** field.



NOTE: Record the path because you will need this information later.



NOTE: The Oracle home path must be different from the Oracle home path that you selected in the Oracle Clusterware installation procedure. You cannot install the Oracle10g Enterprise x64 Edition with RAC and Clusterware in the same home directory.

- 6 Click **Next**.
- 7 In the **Specify Hardware Cluster Installation Mode** window, select **Select All** and click **Next**.
- 8 In the **Product-Specific Prerequisite Checks** window, make sure all the checks are completed successfully, and click **Next**.
- 9 In the **Select Configuration Option** window, select **Install Database Software Only** and click **Next**.
- 10 In the **Summary** window, click **Install**.
- 11 In the **End of Installation** window, perform the procedure as listed in the window.



NOTE: You must perform the procedures as listed in the window before proceeding to the next step.

- 12 After completing the required procedures as listed in the **End of Installation** window, click **Exit**.
- 13 In the **Exit Window**, click **Yes**.

Installing Oracle 10g R2 Patchset 10.2.0.3

- 1 Ensure that only 10.2.0.1 Clusterware and 10.2.0.1 Database binaries are installed on your system and that the seed database is not created yet.
- 2 Download the patchset 10.2.0.3 from the Oracle Metalink website at metalink.oracle.com.
- 3 Unzip the patchset to `%SystemDrive%`.

Installing Patchset 10.2.0.3 for Oracle 10g Clusterware

Before You Begin

Before you install patchset 10.2.0.3 for Oracle 10g Clusterware on your system, perform the following steps:

- 1 Stop nodeapps on all the nodes. Type the following and press <Enter>:

```
%SystemDrive%\%CRS_HOME%\bin> srvctl stop nodeapps -  
n <node name>
```

where %SystemDrive% is the drive on which Oracle home is configured and %CRS_HOME% is the home directory that you created in step 4 in "Installing Oracle Clusterware Version 10.2.0.1" on page 52.

- 2 Run the above command for each node in the cluster.
- 3 Click **Start**→ **Programs**→ **Administrator Tools**→ **Services**.
- 4 Locate all Oracle services and stop them on both nodes.

Installing the Patchset



NOTE: You must install the patchset software from the node where the RAC 10g R2 software was installed.

If this is not the node where you are running the OUI, exit and install the patchset from that node.

- 1 Start the OUI located in the patchset folder, for example:

```
%SystemDrive%\Oracle_patch\setup.exe
```

where %SystemDrive% is the drive on which you unzipped the Oracle patchset.

- 2 In the **Welcome** screen, click **Next**.
- 3 In the **Specify home details** window, select name as **OraCr10g_home** from the drop down list and click **Next**.
- 4 In the **Specify Hardware Cluster Installation Mode** window, click **Next**.
- 5 In the **Summary** window, click **Install**.
- 6 In the **End of Installation** window, perform all the steps listed in the **Summary** window. Do not perform the step instructing you to stop the Oracle services. You should have already done that step *before* you began installing the patchset as mentioned in "Before You Begin" on page 47.

- 7 On the **End of Installation** window, click **Exit**.
- 8 Click **Yes** to exit from the OUI.

Installing Patchset 10.2.0.3 for Oracle 10g Database



NOTE: Before you install the patchset, ensure that all the Oracle services are running.

Complete the following procedures before creating a listener and a seed database.

Installing the Patchset



NOTE: You must install the patchset software from the node where the RAC 10g R2 software was installed. If this node is not the one where you are running the OUI, exit and install the patchset from that node.

- 1 Start the OUI located in the unzipped area of the patchset, for example: %SystemDrive%\Oracle_patch\setup.exe
- 2 In the **Welcome** screen, click **Next**.
- 3 In the **Specify Home Details** window, select the name as OraDb10g_home1 from the drop-down list and click **Next**.
- 4 In the **Specify Hardware Cluster Installation Mode** window, click **Next**.
- 5 In the **Summary** window, click **Install**.
- 6 In the **End of Installation** window, perform all the steps listed in the **Summary** window. Do not perform the step instructing you to stop the Oracle services. You must have already done that before you began installing the patchset as mentioned in "Before You Begin."
- 7 In the **End of Installation** window, click **Exit**.
- 8 Click **Yes** to exit from the OUI.

Downloading the Latest Oracle Patches

Oracle may provide additional patches that were not included when you first downloaded the patchset. To download additional patches:

- 1 Open a Web browser.
- 2 Navigate to the Oracle Metalink website at www.metalink.oracle.com.
- 3 Download any patches appropriate for your installation.

Configuring the Listener

This section describes the steps to configure the listener, which is required for a remote client connection to a database.



NOTE: The procedure in this section requires that the patch already be installed.

On node 1, perform the following steps:

- 1 Click **Start**, select **Run**, and type:
`netca`
- 2 Click **OK**.
- 3 In the **Real Application Clusters, Configuration** window, select **Cluster configuration** and click **Next**.
- 4 In the **Real Application Clusters, Active Nodes** window, select **Select all nodes** and click **Next**.
- 5 In the **Welcome** window, select **Listener configuration** and click **Next**.
- 6 In the **Listener Configuration, Listener** window, select **Add** and click **Next**.
- 7 In the **Listener Configuration, Listener Name** window in the **Listener name** field, accept the default setting and click **Next**.
- 8 In the **Listener Configuration, Select Protocols** window, in the **Selected protocols** field, select **TCP** and click **Next**.
- 9 In the **Listener Configuration, TCP/IP Protocol** window, select **Use the standard port number of 1521** and click **Next**.
- 10 In the **Listener Configuration, More Listeners** window, select **No** and click **Next**.
- 11 In the **Listener Configuration Done** window, click **Next**.
- 12 In the **Welcome** window, click **Finish**.

Creating the Seed Database

This section contains procedures for creating the seed database using OCFS and verifying the seed database.



NOTE: The procedure in this section requires that the patch already be installed.

Perform the following steps to create the seed database using OCFS:

- 1 On node 1, click **Start** and select **Run**.
- 2 In the **Run** field, type `dbca` and click **OK**.
The **Database Configuration Assistant** starts.
- 3 In the **Welcome** window, select **Oracle Real Application Clusters database** and click **Next**.
- 4 In the **Operations** window, click **Create a Database** and click **Next**.
- 5 In the **Node Selection** window, click **Select All** and click **Next**.
- 6 In the **Database Templates** window, click **Custom Database** and click **Next**.
- 7 In the **Database Identification** window, in the **Global Database Name** field, enter a name such as `racdb` and click **Next**.
- 8 In the **Management Options** window, accept the default selections and click **Next**.
- 9 In the **Database Credentials** window, click **Use the Same Password for All Accounts**, type and confirm a new password in the appropriate fields, and click **Next**.
 **NOTE:** Record your new password because you will need this information later for database administration.
- 10 In the **Storage Options** window, select **Cluster File System** and click **Next**.
- 11 In the **Database File Locations** window, select the location for storing database files:
 - a Select **Use Common Location for All Database Files**.
 - b Click **Browse**.
 - c In the **Directory Browse** window, use the pull-down menu and select the CFS drive created in step e in step 12 in "Installing Oracle Clusterware Version 10.2.0.1" on page 42.
 - d Click **OK**.
- 12 Click **Next**.

- 13** In the **Recovery Configuration** window, perform the following steps:
 - a** Select **Specify Flash Recovery Area**.
 - b** Click **Browse**.
 - c** In the **Directory Browse** window, use the pull-down menu and select the CFS drive created in step e in step 13 in "Installing Oracle Clusterware Version 10.2.0.1" on page 42.
 - d** Click **OK**.
 - e** In the **Flash Recovery Area Size** text box type the total amount of size that was created in step 2 in "Preparing the Database Disk and Flash Recovery Area for Database Storage With OCFS" on page 39 for Flash Recovery Area.
- 14** Select **Enable Archiving**.
- 15** Click **Edit Archive Mode Parameters**.
 - a** In the **Edit Archive Mode Parameters** window, ensure that the path listed under the **Archive Log Destinations** is as follows:

X:/

where X is the CFS drive letter created in step 2 in "Preparing the Database Disk and Flash Recovery Area for Database Storage With OCFS" on page 39 for Flash Recovery Area.
 - b** Click **OK**.
- 16** Click **Next**.
- 17** In the **Database Content** window, accept the default values and click **Next**.
- 18** In the **Database Services** window, click **Next**.
- 19** In the **Initialization Parameters** window, click **Next**.
- 20** In the **Database Storage** window, click **Next**.
- 21** In the **Creation Options** window, accept the default values, and click **Finish**.
- 22** In the **Summary** window, click **OK**.

The **Database Configuration Assistant** window appears, and the Oracle software creates the database.

 **NOTE:** This procedure may take several minutes to complete.

- 23** In the **Database Configuration Assistant** window, click **Yes**.
When completed, the **Database Configuration Assistant** window provides database configuration information.
- 24** Record the information in the **Database Configuration Assistant** window for future database administration.
- 25** Click **Exit**.
The **Start Cluster Database** window appears and the cluster database starts.

Installing Oracle RAC 10g R2 Using ASM

 **NOTE:** If you are installing Oracle using OCFS, ignore the following steps and follow the procedures in "Installing Oracle RAC 10g R2 Using OCFS" on page 41.

This section provides information about installing the Oracle RAC 10g R2 software. The following topics are covered:

- Installing Oracle Clusterware Version 10.2.0.1
- Installing Oracle 10g Database with Real Application Clusters 10.2.0.1
- Installing Patchset 10.2.0.3
- Configuring the Listener
- Creating the Seed Database

Installing Oracle Clusterware Version 10.2.0.1

- 1** On node 1, insert the *Oracle Clusterware* CD into the CD drive.
The OUI starts and the **Welcome** screen appears.

If the **Welcome** screen does not appear:

- a** Click **Start** and select **Run**.
- b** In the **Run** field, type the following and click **OK**:

```
%CD drive%\autorun\autorun.exe
```

where %CD drive% is the drive letter of your CD drive.

- 2** In the **Oracle Clusterware** window, click **Install/Deinstall Products**.
- 3** In the **Welcome** screen, click **Next**.

- 4 In the **Specify Home Details** window, accept the default settings and click **Next**.



NOTE: Record the OraCR10g_home (CRS Home) path because you will need this information later.

- 5 In the **Product-Specific Prerequisite Checks** window, click **Next**.
- 6 In the **Specify Cluster Configuration** window, perform the following steps:
 - a Verify the public, private, and virtual Host names for the primary node.
 - b If you want to change these values, click **Edit** and enter the desired values, and click **OK**.
 - c Click **Add**.
 - d Enter the public, private, and virtual Host names for the second node, and click **OK**.
- 7 Click **Next**.

The **Specify Network Interface Usage** window appears, displaying a list of cluster-wide network interfaces.

- 8 In the **Interface Type** drop-down menus, configure the public **Interface Type** as **Public** and the private **Interface Type** as **Private** (if required) by selecting the **Interface Name** and clicking **Edit**. Select the correct **Interface Type** and click **OK**.
- 9 Click **Next**.
- 10 In the **Cluster Configuration Storage** screen, perform the following steps for the OCR disk:
 - a Locate the two 120 MB partitions that you created in the subsection "Preparing the OCR and Voting Disks for Clusterware" on page 37.
 - b Select the first partition and click **Edit**.
 - c In the **Specify Disk Configuration** window, select **Place OCR (Primary)** on this partition and click **OK**.
 - d Select the second partition and click **Edit**.
 - e In the **Specify Disk Configuration** window, select **Place OCR (Mirror)** on this partition and click **OK**.

- 11 In the **Cluster Configure Storage** screen, perform the following steps for the Voting disk:
 - a Locate the three 50 MB partitions that you created in the subsection "Preparing the OCR and Voting Disks for Clusterware" on page 37.
 - b Select the first partition and click **Edit**.
 - c In the **Specify Disk Configuration** window, select **Place Voting Disk on this partition** and click **OK**.
 - d Repeat steps b and c on the remaining Voting Disk partitions.
- 12 Click **Next**.
- 13 Ignore the warning messages and click **OK**.
- 14 In the **Summary** window, click **Install** to start the installation procedure.



NOTE: If a failure occurs in the Configuration Assistant window, perform the following steps and see "Troubleshooting" on page 66 and "Working Around Clusterware Installation Failure" on page 66 of this document.

The **Install** window appears, displaying an installation progression bar.

The **Configuration Assistant** window appears and the OUI runs a series of configuration tools.

The **End of Installation** window appears.

- 15 Click **Exit** to finish the OUI session.
- 16 In the **Exit** window, click **Yes**.

Installing Oracle10g Database With Real Application Clusters 10.2.0.1



NOTE: If you are installing Oracle using OCFS, skip these steps and go to "Installing Oracle RAC 10g R2 Using OCFS" on page 41

- 1 Insert the *Oracle Database 10g Release 2* CD into the CD drive.

The OUI starts and the **Welcome** screen appears.

If the **Welcome** screen does not appear:

- a Click **Start** and select **Run**.
- b In the **Run** field, type:
`%CD drive%\autorun\autorun.exe`

where `%CD drive%` is the drive letter of your CD drive.

- 2 Click **OK** to continue.

The OUI starts and the **Welcome** window appears.

- 3 Click **Next**.

- 4 In the **Select Installation Type** window, click **Enterprise Edition** and click **Next**.

- 5 In the **Specify Home Details** window under **Destination**, verify the following:

- In the **Name** field, the Oracle database home name is `OraDb10g_home1`
- In the **Path** field, the complete Oracle home path is `%SystemDrive%\oracle\product\10.2.0\db_1`
where `%SystemDrive%` is the user's local drive.



NOTE: Record the path because you will need this information later.



NOTE: The Oracle home path must be different from the Oracle home path that you selected in the Oracle Clusterware installation procedure. You cannot install the Oracle Database 10g R2 Enterprise x64 Edition with RAC and Clusterware in the same home directory.

- 6 Click **Next**.

- 7 In the **Specify Hardware Cluster Installation Mode** window, click **Select All** and click **Next**.

- 8 In the **Product-Specific Prerequisite Checks** window, click **Next**.

- 9 In the **Select Configuration Option** window, select **Install database Software only**, and click **Next**.

- 10 In the **Summary** window, click **Install**.

- 11 In the **End of Installation** window, perform the steps as listed.



NOTE: You should perform the steps as listed in the window before proceeding with the next step.

- 12 Click **Exit**.

Installing Patchset 10.2.0.3



NOTE: The following patchset installation steps install only the Oracle softwares like 10.2.0.1 Clusterware and 10.2.0.1. Database binaries with seed database that are not yet created on your system.

- 1 Download the patchset 10.2.0.3 from the Oracle Metalink website located at metalink.oracle.com.
- 2 Unzip the patchset to the following location `%SystemDrive%`, where `%SystemDrive%` is the user's local drive.

Installing Patchset 10.2.0.3 for Oracle 10g Clusterware

Before You Begin

- 1 Stop the nodeapps on all the nodes. Type the following and press <Enter>.

```
%SystemDrive%:\%CRS_HOME%\bin> srvctl stop nodeapps -n <node_name>
```

where `%SystemDrive%` is the user's local drive.
- 2 Stop all the oracle services on all the nodes.
- 3 Click **Start** → **Programs** → **Administrator Tools** → **Services**.
- 4 Locate all Oracle services and stop them on both nodes.

Installing the Patchset



NOTE: You must install the patchset software from the node where the Oracle RAC 10g R2 software was installed. If this is not the node where you are running the OUI, exit and install the patchset from that node.

- 1 Start the OUI located in the patchset folder.
- 2 In the Welcome window, click **Next**.
- 3 In the **Specify home details** window, select the name as **OraCr10g_home** and install the patchset to the Clusterware home and click **Next**.
- 4 In the **Specify Hardware Cluster Installation Mode Window**, click **Next**.
- 5 In the Summary window, click **Install**.
- 6 At the **End of installation** window, perform all the steps listed in the Summary window except step 1.

- 7 At the **End of installation** screen, click **Exit** and then click **Yes** to exit from the OUI.

Installing Patchset 10.2.0.3 for Oracle 10g Database



NOTE: Complete the following steps before creating a listener and a seed database. Ensure that all the Oracle services are running.



NOTE: You must install the patchset software from the node where the Oracle RAC 10g R2 software was installed. If this is not the node where you are running the OUI, exit and install the patchset from that node.

Patchset Installation Steps

- 1 Start the OUI located in the patchset folder.
- 2 In the **Welcome** window, click **Next**.
- 3 In the **Specify home details** window, select the name as **OraDb10g_home1** from the drop-down list to install the patchset to Oracle home and click **Next**.
- 4 In the **Specify Hardware Cluster Installation Mode** window, click **Next**.
- 5 In the **Summary** window, click **Install**.

During the installation, the following error message may appear, **Error in writing to file oci.dll**. To work around this issue, perform the following steps:

- a Cancel the patchset installation.
 - b Rename the `%Oracle_home%\BIN` directory to `\bin_save`.
 - c Reboot the system.
 - d After the reboot, rename the `\bin_save` file to `\bin`.
 - e Run the `setup.exe` file from the patchset folder. Allow all the Oracle default services to run.
- 6 From the **End of Installation** screen, perform the necessary steps listed in the **Summary** windows.
 - 7 At the **End of Installation** screen, click **Exit** and then click **Yes** to exit the OUI.

Configuring the Listener

This section contains procedures to configure the listener, which is required to establish a remote client connection to a database.

Perform the following steps on node 1:

- 1 Click **Start**, select **Run** and type `netca`.
- 2 Click **OK**.
- 3 In the **Real Application Clusters Configuration** window, select **Cluster configuration** and click **Next**.
- 4 In the **Real Application Clusters Active Nodes** window, select **Select All nodes** and click **Next**.
- 5 In the **Welcome** window, select **Listener configuration** and click **Next**.
- 6 In the **Listener Configuration Listener** window, select **Add** and click **Next**.
- 7 In the **Listener Configuration Listener Name** window, select the **default setting** in the **Listener name** field and click **Next**.
- 8 In the **Listener Configuration Select Protocols** window, select **TCP** in the **Selected protocols** field and click **Next**.
- 9 In the **Listener Configuration TCP/IP Protocol** window, select **Use the standard port number of 1521** and click **Next**.
- 10 In the **Listener Configuration More Listeners** window, select **No** and click **Next**.
- 11 In the **Listener Configuration Done** window, click **Next**.
- 12 In the **Welcome** window, click **Finish**.

Creating the Seed Database

Perform the following steps to create the seed database using Oracle ASM:

- 1 Verify the Oracle Clusterware is running.
 - a Open a command prompt window. Click **Start** and select **Run**; type `cmd`; and press `<Enter>`.
 - b Type `crsctl check crs`

- b** Select **Create initialization parameter file (IFILE)**.
 - c** Click **Next**.
- 13** In the **Database Configuration Assistant** window, click **OK**.
The **ASM Creation** window appears, and the ASM Instance is created.
 -  **NOTE:** If the warning message **Failed to retrieve network listener resources** appears, click **Yes** to allow DBCA to create the appropriate listener resources.
- 14** In the **ASM Disk Groups** window, click **Create New**.
- 15** In the **Create Disk Group** window, enter the information for the database files.
 - a** In the **Disk Group Name** field, type a name for the new disk group.
For example, **DATABASE**.
 - b** In the **Redundancy** box, select **External**.
 - c** Click **Stamp Disks**.
 - d** Select **Add or change label** and click **Next**.
 - e** In the **Select disks** screen, select the disks that you plan to use for the database files. Note that the **Status** is marked as **Candidate device**.
 - f** In the **Generate stamps with this prefix** field, keep the default settings and click **Next**.
 - g** In the **Stamp disks** window, click **Next**.
 - h** Click **Finish** to save your settings.
 - i** Select the check boxes next to the available disks and click **OK**.
- 16** In the **ASM Disk Groups** window, click **Create New**.
- 17** In the **Create Disk Group** window, enter the information for the Flash Recovery Area.
 - a** In the **Disk Group Name** field, type a name for the new disk group.
For example, **FLASH**.
 - b** In the **Redundancy** box, select **External**.
 - c** Click **Stamp disks**.

- d** In the **Select disks** screen, select the disk which you plan to use for the Flash Recovery Area. Note that the **Status** is marked as **Candidate device**.
- e** In the **Generate stamps with this prefix** field, type **FLASH**, and click **Next**.
- f** In the **Stamp disks** window, click **Next**.
- g** Click **Finish** to save your settings.
- h** Select the check boxes next to the available disks and click **OK**.

The **ASM Disk Group Window** appears, indicating that the software is creating the disk group.

When completed, the **FLASH** disk group appears in the **Disk Group Name** column.

- 18** Select only the Disk Group Name that you assigned to the database in step 15 (for example, **+DATABASE/**) and click **Next**.
- 19** In the **Database File Locations** window, select **Use Oracle-Managed Files** and **Multiplex Redo Logs and Control Files** and click **Next**.
- 20** In the **Recovery Configuration** window, perform the following steps:
 - a** Select **Specify Flash Recovery Area**.
 - b** Click **Browse**.
 - c** Select the **FLASH** disk group that you created in step 17 and click **OK**.
 - d** In the **Flash Recovery Area Size** text box type the total size of the flash disk group created in step 17.
 - e** Select **Enable Archiving**.
 - f** Click **Edit Archive Mode Parameters**.
 - g** In the **Edit Archive Mode Parameters** window, ensure that the path listed under the **Archive Log Destinations** is as follows: **+FLASH/**, where **FLASH** is the Flash Recovery Area disk group name that you specified in step a of step 17.
 - h** Click **Next**.
- 21** In the **Database Content** window, click **Next**.
- 22** In the **Database Services** window, click **Next**.
- 23** In the **Initialization Parameters** window, click **Next**.

- 24 In the **Database Storage** window, click **Next**.
- 25 In the **Creation Options** window, click **Finish**.
- 26 In the **Summary** window, click **OK**.

The **Database Configuration Assistant** window appears, and the Oracle software creates the database.

 **NOTE:** This procedure may take several minutes to complete.

When completed, the **Database Configuration Assistant** window provides database configuration information.

- 27 Record the information in the **Database Configuration Assistant** window for future database administration.
- 28 Click **Exit**.

The **Start Cluster Database** window appears and the cluster database starts.

Adding a New Node to an Existing Oracle 10g RAC Cluster

The following describes how to add nodes and instances to Oracle RAC databases on Windows.

Preparing the Node to be Added to a Cluster

Perform the following steps on the node(s) that you want to add to an existing cluster:

- 1 Install and configure the operating system using the *Deployment* CDs.
- 2 Configure the networking and fiber channel storage subsystem.

Make sure that you can execute the following command from *each* of the existing nodes of your cluster where the *host_name* is the public network name of the new node:

```
NET USE \\host_name\C$
```

You have the required administrative privileges on each node if the operating system responds with:

```
Command completed successfully.
```

 **NOTE:** If you are using ASM, then make sure that the new nodes can access the ASM disks with the same permissions as the existing nodes.

 **NOTE:** If you are using Oracle Cluster File Systems, then make sure that the new nodes can access the cluster file systems in the same way that the other nodes access them.

Now the node(s) is ready to be added to an existing cluster.

The steps to add a node to an existing cluster can be summarized as below:

- 1 Adding Nodes at the Oracle Clusterware Layer
- 2 Adding Nodes at the Oracle RAC Database Layer
- 3 Adding Database Instances to New Nodes

Adding Nodes at the Oracle Clusterware Layer

Perform the following steps:

- 1 On one of the *existing* nodes, go to the `CRS home\oui\bin` directory. Run the `addNode.bat` script to start the OUI.
- 2 The OUI runs in the add node mode and the OUI **Welcome** page appears. Click **Next** and the **Specify Cluster Nodes for Node Addition** page appears.
- 3 The upper table on the **Specify Cluster Nodes for Node Addition** page shows the existing nodes associated with the CRS home from which you launched the OUI. Use the lower table to enter the public and private node names of the new nodes.
- 4 If all the checks succeed, then the OUI displays the **Node Addition Summary** page.
- 5 Click **Next** and the OUI displays the **Cluster Node Addition Progress** page.
- 6 On completion, click **Exit** to end the OUI session. After the OUI displays the **End of Node Addition** page, click **Exit** to end the OUI session.
- 7 Execute the following command to identify the node names and node numbers that are currently in use:

```
CRS home\bin\olsnodes -n
```

- 8 Execute the `crssetup.exe` command using the next available node names and node numbers to add CRS information for the new nodes. For example:

```
crssetup.exe add -nn publicnode3,3 -pn pvtnode3,3  
-vn vipnode3,3
```

- 9 Execute the `racgons` utility from the `bin` subdirectory of the CRS home to configure the Oracle Notification Services (ONS) port number as follows:

```
racgons add_config new_node_name:4948
```

After you have completed the procedures in this section for adding nodes at the Oracle Clusterware layer, you have successfully extended the CRS home from your existing CRS home to the new nodes.

Adding Nodes at the Oracle RAC Database Layer

- 1 From the `%ORACLE_HOME%\oui\bin`, run the `addNode.bat` script. This starts the OUI in the add node mode and displays the OUI **Welcome** page. Click **Next** on the **Welcome** page and the OUI displays the **Specify Cluster Nodes for Node Addition** page.
- 2 The **Specify Cluster Nodes for Node Addition** page has a table showing the existing nodes associated with the Oracle home from which you launched the OUI. A node selection table appears on the bottom of this page showing the nodes that are available for addition. Select the nodes that you want to add and click **Next**.

If all of the checks succeed, then the OUI displays the **Node Addition Summary** page.

- 3 Click **Finish** and the OUI displays the **Cluster Node Addition Progress** page.
- 4 After the OUI displays the **End of Node Addition** page, click **Exit** to end the OUI session.
- 5 Execute the `VIPCA` utility from the `bin` subdirectory of the Oracle home using the `-nodelist` option with the following syntax that identifies the complete set of nodes that are now part of your RAC database beginning with `Node1` and ending with `NodeN`:

```
vipca -nodelist Node1,Node2,Node3,...NodeN
```

- 6 Add a listener to the new node only by running the **Net Configuration Assistant (NetCA)**.

After completing the procedures in the previous section, the new nodes are defined at the cluster database layer. New database instances can now be added to the new nodes.

Adding Database Instances to New Nodes

Execute the following procedures for each new node to add instances:

- 1 Choose **Start > Programs > Oracle - HOME_NAME > Configuration and Migration Tools > Database Configuration Assistant**.
- 2 The DBCA displays the **Welcome** page for RAC. Click **Help** on any DBCA page for additional information.
- 3 Select **Real Application Clusters database**, click **Next**, and the DBCA displays the **Operations** page.
- 4 Select **Instance Management**, click **Next**, and the DBCA displays the **Instance Management** page.
- 5 Select **Add Instance** and click **Next**. The DBCA displays the **List of Cluster Databases** page that shows the databases and their current status, such as **ACTIVE**, or **INACTIVE**.
- 6 From the **List of Cluster Databases** page, select the active RAC database to which you want to add an instance.
- 7 Click **Next** to add a new instance. The DBCA displays the **Adding an Instance** page.
- 8 On the **Adding an Instance** page, enter the instance name in the field at the top of this page. Then select the new node name from the list, click **Next**, and the DBCA displays the **Services Page**.
- 9 Enter the services information for the new node's instance, click **Next**, and the DBCA displays the **Instance Storage** page.
- 10 Click **Finish**, and the DBCA displays a **Summary** dialog.

- 11 Review the information on the **Summary** dialog and click **OK**. The DBCA displays a progress dialog showing the DBCA performing the instance addition operation. When the DBCA completes the instance addition operation, the DBCA displays a dialog asking whether you want to perform another operation.
- 12 Click **No** and exit the DBCA, or click **Yes** to perform another operation.

Troubleshooting

Working Around Clusterware Installation Failure

Oracle Clusterware Configuration Assistant Fails

In the **Configuration Assistants** window, if the installation fails using the **Oracle Clusterware Configuration Assistant**, then perform the following:

- 1 Open the file:
`%ORA_CLUSTERWARE_HOME%\cfgtoollogs\configToolFailedCommands` where `%ORA_CLUSTERWARE_HOME%` is the CRS home directory that you created in "Installing Oracle Clusterware Version 10.2.0.1" on page 42.
- 2 Copy and run the first three commands (with the parameters) listed in the file from the DOS command prompt.
- 3 Follow the section "Virtual Private IP Configuration Assistant Fails" on page 66, below, to run the failed virtual private IP configuration assistants (VIPCA).

Virtual Private IP Configuration Assistant Fails

If the VIPCA fails during the installation of Oracle Clusterware, the following message may display:

```
Virtual Private IP Configuration Assistant failed
```

If this occurs, perform the following steps to work around the error. These steps are detailed in Metalink Note ID 338924.1. This generally occurs if the Public interface is configured with an IP address in the networks 10.0.0/8, 172.16.0.0/16 or 192.168.1.0/24.

- 1 Click **Start** and select **Run**.
- 2 In the **Run** field, type the following and click **OK**:
`%SystemDrive%\Oracle\product\10.2.0\crs\bin\vipca`
where `%SystemDrive%` is the user's local drive.
- 3 Follow the steps in VIPCA by selecting the interface appropriate for the public interface, and specifying the correct VIP address to be used.
- 4 When done, click **Finish**.

Uninstalling Oracle Clusterware



NOTE: Copy the `GUIOraObjman` folder to a different location before uninstalling Clusterware. Utilities in this folder can be used to clean the share disks later.

You may be required to uninstall Oracle Clusterware to troubleshoot the following issues:

- The Oracle Clusterware installation procedure failed.
- The Configuration Assistant failed to install successfully.

To uninstall Oracle Clusterware, run OUI on the cluster node, delete any remaining Oracle services, and clean the storage devices.

Running OUI

- 1 On node 1, open an Explorer window and navigate to the following directory:
`%SystemDrive%\oracle\product\10.2.0\crs\oui\bin`
where `%SystemDrive%` is the user's local drive.
- 2 Double-click `setup.exe` to launch the OUI.
- 3 In the **Welcome** window, click **Deinstall Products**.
- 4 In the **Inventory** window, select `OraCr10g_home` and then click **Remove**.
- 5 In the **Confirmation** window, click **Yes**.
If an error message appears, click **Cancel**.

- 6 In the **Welcome** window, click **Cancel**.
- 7 When prompted, click **Cancel**, and then click **Yes**.

Deleting Oracle Services

- 1 On node 1, launch the **Services** console.
 - a Click **Start** and select **Run**.
 - b In the **Run** field, type the following, and click **OK**:

```
services.msc
```

The **Services** window appears.

- 2 Identify and delete any remaining Oracle services.
To delete a service:
 - a Click **Start** and select **Run**.
 - b In the **Run** field, type `cmd` and click **OK**.
 - c Open a command prompt, type the following, and press `<Enter>`:

```
sc delete <oracle_service_name>
```
 - d Repeat step c for each additional service that you need to remove.
- 3 Restart node 1 and log in as the administrator.
- 4 Restart each of the other nodes and log in as the administrator.

Cleaning the Storage Devices

- 1 Clean the partitions that will be configured for the OCR registry (OCRCFG, OCRMIRROCFG) and the voting disks, **Votedsk1**, **Votedsk2**, and **Votedsk3**.
 - a Click **Start** and select **Run**.
 - b In the **Run** field, type `cmd` and click **OK**.
 - c At the command prompt, type the following and press `<Enter>`:

```
%SystemDrive%\oracle\product\10.2.0\crs\bin\ExportSYMLinks
```

where `%SystemDrive%` is the user's local drive.

The Oracle Symbolic Link Exporter (ExportSYMLinks) imports the symbolic links to the `SYMMAP.TBL` file to your current directory.

- d At the command prompt, type the following and press <Enter>:
`notepad SYMMAP.TBL`

- 2 Ensure that `OCRCFG`, `OCRMIRRORCFG`, `Votedsk1`, `Votedsk2`, and `Votedsk3` appear in the file.

If `OCRCFG`, `OCRMIRRORCFG`, `Votedsk1`, `Votedsk2`, and `Votedsk3` do not appear in the file, assign `OCRCFG`, `OCRMIRRORCFG`, `Votedsk1`, `Votedsk2`, and `Votedsk3` to the appropriate disk and save the file.

Use the Oracle Symbolic Link Importer (ImportSYMLinks) to import the symbolic links into the assigned storage disks (`OCRCFG`, `OCRMIRRORCFG`, `Votedsk1`, `Votedsk2`, and `Votedsk3`).

At the command prompt, type the following and press <Enter>:

```
%SystemDrive%\oracle\product\10.2.0\crs\bin\ImportSYMLinks
```

where `%SystemDrive%` is the user's local drive.

- 3 Using the Oracle Logical Partition Formatter (LogPartFormat), format the `OCRCFG`, `OCRMIRRORCFG`, `Votedsk1`, `Votedsk2`, and `Votedsk3` partitions on both nodes.

At the command prompt, type the following commands and press <Enter> after each command:

```
%SystemDrive%\oracle\product\10.2.0\crs\bin\LogPartFormat \\. \OCRCFG
```

```
%SystemDrive%\oracle\product\10.2.0\crs\bin\LogPartFormat \\. \Votedsk1
```

where `%SystemDrive%` is the user's local drive.

The following message appears:

```
Are you sure you want to continue...(Y/N)?
```

- 4 Type `y` and press <Enter>.

- 5 Launch the Oracle GUI Object Manager.

At the command prompt, type the following and press <Enter>:

```
%SystemDrive%\ora_bin_utils\GUIOracleOBJManager.exe
```

where *%SystemDrive%* is the user's local drive.

The **Oracle Object Manager** window appears.

- 6 Delete the symlinks for the OCR (OCRCFG and OCRMIRRORCFG) and the voting disks (Votedsk1, Votedsk2, and Votedsk3).

- a Select **OCRCFG**, **OCRMIRRORCFG**, **Votedsk1**, **Votedsk2**, and **Votedsk3**.

- b Click **Options** and select **Commit**.

If successful, the **OCRCFG**, **OCRMIRRORCFG**, **Votedsk1**, **Votedsk2**, and **Votedsk3** entries disappear.

- c Click **Options** and select **Exit** to close the Oracle Object Manager.

- 7 Launch the Computer Management Console.

- a On the Windows desktop, click **Start** and select **Run**.

- b In the **Run** field, type the following and press <Enter>:

```
compmgmt.msc
```

The **Computer Management Console** window appears.

- 8 Delete the ASM or OCFS partitions.

- a In the **Computer Management Console** window, click **Storage** and select **Disk Management**.

- b Right-click the first partition and select **Delete Logical Drive**.

- c When prompted, click **Yes**.

- d Repeat step b and step c for each remaining partition until all partitions; including the original extended partition have been deleted.

- 9 Restart node 1 and log in as administrator.

- 10 After you are logged in as administrator on node 1, restart each of the remaining nodes and log in as administrator.

- 11 Repeat the procedures "Preparing the Disks for Oracle Clusterware" on page 36 and "Removing the Assigned Drive Letters" on page 41 to recreate your logical partitions and the procedure "Installing Oracle RAC 10g R2 Using OCFS" on page 41 to re-install Oracle RAC for OCFS, or "Installing Oracle RAC 10g R2 Using ASM" on page 52 to re-install Oracle RAC for ASM.

Additional Troubleshooting Issues

Table 1-10 provides recommended actions for problems that you may encounter while deploying and using your Windows Server 2003 operating system and Oracle Database 10g R2 software.

Table 1-10. Troubleshooting

| Category | Problem / Symptom | Cause | Recommended Corrective Action |
|------------------------|-------------------------------|--|--|
| PowerPath Installation | PowerPath installation fails. | Unknown installation error. | Reboot the system on which the PowerPath installation fails. |
| NIC Teaming | Broadcom NIC teaming fails. | <p>The following steps may result in a NIC teaming failure:</p> <ul style="list-style-type: none">• One of the Broadcom NICs that was used in the NIC teaming fails or is disabled. Due to the availability of the second NIC, the private network is still active on this node through the second NIC.• When the first NIC is still down or disabled, the second NIC in the teaming also fails or is disabled. This failure causes the private network to go down completely on this node. The private IP address on this node cannot be pinged. | <p>The most likely cause of this issue is a Spanning Tree Protocol on your switch. If this issue is caused by a Spanning Tree Protocol, perform one of the following procedures:</p> <ul style="list-style-type: none">• Turn off Spanning Tree on the switch.• Enable Port Fast Learning (or equivalent, which may be called something different depending on the brand of switch) on the ports of the switch to which your teamed NICs are attached.• Use Broadcom’s LiveLink feature by right-clicking the team, choosing Enable LiveLink, and following the instructions in the window. <p>NOTE: Though the suggested solutions may fix the above mentioned issue, be aware of the implications or issues that may arise from enabling Port Fast Learning or turning off Spanning Tree on your switches.</p> |

Table 1-10. Troubleshooting (*continued*)

| Category | Problem / Symptom | Cause | Recommended Corrective Action |
|----------|-------------------|--|-------------------------------|
| | | <ul style="list-style-type: none">• When the second NIC that failed or was disabled becomes enabled, the private network of this node remains inactive. | |
| | | <p>NOTE: A private network becomes inactive only if the failed second NIC becomes enabled. If the first failed NIC becomes enabled, the private network becomes active.</p> | |

Table 1-10. Troubleshooting (continued)

| Category | Problem / Symptom | Cause | Recommended Corrective Action |
|-------------------------------|---|---|---|
| Installing Oracle Clusterware | During Clusterware installation you get the error message: The specified nodes are not clusterable. | The administrative or the account used to install Oracle has a blank password associated with it. | <p>Perform the following steps:</p> <ol style="list-style-type: none"> 1 Right-click My Computer and select Manage. 2 In the Computer Management Window in the left pane, expand System Tools and Local Users and then expand Groups. 3 Click Users in the left pane. 4 In the right pane, right-click the administrative account being used to install Oracle and select Set Password. 5 A warning window displays. Ignore the message and click Proceed. 6 In the Set Password window, enter the passwords and click OK. 7 Log off the machine and log back in with the administrative account you just changed/assigned the password for. 8 Restart the Clusterware installation. |

Table 1-10. Troubleshooting (continued)

| Category | Problem / Symptom | Cause | Recommended Corrective Action |
|-------------------------------|--|---|---|
| Installing Oracle Clusterware | The Oracle Clusterware installation fails. The Configuration Assistant fails to install successfully. | The symlinks for OCRCFG and/or Votedsk1 are unavailable. One or more storage devices need to be reformatted. | Perform the following procedures: 1 Uninstall Oracle Clusterware using OUI. 2 Uninstall any remaining Oracle services. 3 Clean the storage devices. See "Uninstalling Oracle Clusterware" on page 67 for more information. |
| Oracle Clusterware | The cluster node restarts with a blue screen. | The cluster node cannot communicate with the storage disks. | Perform the following steps: 1 Restart the cluster node. 2 During POST, press <F8>. 3 In the Windows Advanced Options Menu screen, select Safe Mode . 4 Select the appropriate operating system. 5 Log on to the system. 6 In the Desktop screen, click OK . 7 On the Windows desktop, right-click My Computer and select Manage . 8 In the Computer Management window, expand Services and Applications . 9 Click Services . 10 Right-click the first Oracle service and select Properties . |

Table 1-10. Troubleshooting (continued)

| Category | Problem / Symptom | Cause | Recommended Corrective Action |
|----------|-------------------|-------|---|
| | | | <p>11 Click the Startup drop-down menu and record the default startup type for this service.</p> <p>12 In the Startup drop-down menu, select Disabled.</p> <p>13 Repeat step 10 through step 12 for all remaining Oracle services.</p> <p>14 Verify the following:</p> <ul style="list-style-type: none"> • The storage system is functioning properly. • All fiber-optic cables are connected and secure. • The cluster node can access the shared storage disks. <p>See "Installing the Host-Based Software Needed for Storage" on page 34 and "Verifying Multi-Path Driver Functionality" on page 36.</p> <p>15 Repeat step 1 through step 14 and reset each Oracle service back to its original setting.</p> |

Table 1-10. Troubleshooting (continued)

| Category | Problem / Symptom | Cause | Recommended Corrective Action |
|--------------------|---|--|---|
| System blue screen | The cluster nodes generate a blue screen. | The cluster nodes cannot access the voting disk. | <p>1 Ensure that the HBA connection mode firmware settings are configured properly for your storage configuration.</p> <p>If your cluster nodes and storage system are configured in a direct-attached configuration, configure the Connection mode as: 0 - loop only.</p> <p>If your cluster nodes and storage system are connected to each other through a Fibre Channel switch, configure the Connection mode as 2 - loop preferred, otherwise point-to-point.</p> <p>2 If the problem persists, increase the CSS misscount to a value greater than 120.</p> |

Table 1-10. Troubleshooting (continued)

| Category | Problem / Symptom | Cause | Recommended Corrective Action |
|----------|-------------------|-------|---|
| | | | <p>3 Perform the following:</p> <ul style="list-style-type: none"> a Shut down all nodes except node 1. b On node 1, open a command prompt. c Type the following, and press <Enter>: <pre>%ORA_CLUSTERW ARE_HOME%\bin</pre> where <pre>%ORA_CLUSTERW ARE_HOME%</pre> is the CRS home directory that you created in "Installing Oracle Clusterware Version 10.2.0.1" on page 52. d At the command prompt, type the following and press <Enter>: <pre>crsctl set css misscount n</pre> where <i>n</i> is a value greater than 120. <p>4 Restart node 1 and log on as administrator.</p> <p>5 Restart each of the other nodes and log on as administrator.</p> |

Table 1-10. Troubleshooting (continued)

| Category | Problem / Symptom | Cause | Recommended Corrective Action |
|-----------------|------------------------------|--|--|
| Storage | Disks appear as unreachable. | <p>On the Windows desktop, when you right-click My Computer, select Computer Management, and then click Disk Management, the disks appear unreachable.</p> <p>Causes:</p> <ul style="list-style-type: none">• The LUNs are not assigned to the cluster nodes.• Improper cabling.• The HBA drivers are not installed on the cluster node(s). | <p>Ensure that the storage LUNs are assigned to both cluster nodes.</p> <p>Ensure that the fiber-optic cables connected to the cluster nodes and storage system are installed correctly.</p> <p>See "Cabling Your Dell EMC Fibre Channel Storage" on page 19 for more information.</p> |

Table 1-10. Troubleshooting (continued)

| Category | Problem / Symptom | Cause | Recommended Corrective Action |
|----------|----------------------------------|--|--|
| Storage | SCSI disk devices do not appear. | <p>On the Windows desktop, when you right-click My Computer, select Computer Management, and then click Disk drivers, the SCSI disk devices do not appear.</p> <p>Causes:</p> <ul style="list-style-type: none"> • The LUNs are not assigned to the cluster nodes. • Improper cabling. • The HBA drivers are not installed on the cluster node(s). | <p>Ensure that the storage LUNs are assigned to both cluster nodes.</p> <p>Perform the following steps.</p> <ol style="list-style-type: none"> 1 On the Windows desktop, right-click My Computer and select Manage. 2 In the Manage window, expand Device Manager. 3 In the right-window pane, right-click the host computer name and select Scan for hardware changes. 4 Repeat step 3 until the disk devices appear. 5 Restart the system (if required). <p>Ensure that the fiber optic cables connected to the cluster nodes and storage system are installed correctly.</p> <p>See "Cabling Your Dell EMC Fibre Channel Storage" on page 19 for more information.</p> |

Table 1-10. Troubleshooting (continued)

| Category | Problem / Symptom | Cause | Recommended Corrective Action |
|------------------------------|---|--|--|
| VIPCA | The VIPCA configuration fails. | The public network adapter interface (or the network interface assigned for VIP in case 4 network interfaces) name is not identical on both cluster nodes. | <p>Ensure that the public network adapter interface name is identical on both cluster nodes.</p> <p>To verify the public network adapter interface name:</p> <ol style="list-style-type: none"> 1 On node 1, click Start and select Settings→Control Panel→Network Connections. 2 In the Network Connections window, right-click the public network adapter that you want to rename and select Rename. 3 Repeat step 1 and step 2 on each of the remaining nodes. |
| Uninstall Oracle Clusterware | Configuration assistant fails to install repetitively | Unable to clean removal Previous Installation | Even though Oracle is uninstalled using the GUI, the empty directories in Oracle home and the Oracle folder under Program Files remain; these folders should be manually deleted. |

Getting Help

Dell Support

For detailed information about using your system, see the documentation that came with your system components. For white papers, Dell Supported Configurations, and general information, visit dell.com/10g. For Dell technical support for your hardware and operating system software and to

download the latest updates for your system, visit the Dell Support website at support.dell.com. Information about contacting Dell is provided in your system *Installation and Troubleshooting Guide*.

Dell Enterprise Training and Certification is now available; see dell.com/training for more information. This training service may not be offered in all locations.

Oracle Support

For information about Oracle software and application clusterware training and contacting Oracle, see the Oracle website at www.oracle.com or your Oracle documentation.

Technical support, downloads, and other technical information are available at the Oracle MetaLink website at www.metalink.oracle.com.

Obtaining and Using Open Source Files

The software contained on the *Deployment* CD is an aggregate of third-party programs as well as Dell programs. Use of the software is subject to designated license terms. All software that is designated as under the terms of the GNU GPL may be copied, distributed, and/or modified in accordance with the terms and conditions of the GNU General Public License, Version 2, June 1991. All software that is designated as under the terms of the GNU LGPL (or Lesser GPL) may be copied, distributed, and/or modified in accordance with the terms and conditions of the GNU Lesser General Public License, Version 2.1, February 1999. Under these GNU licenses, you are also entitled to obtain the corresponding source files by contacting Dell at 1-800-WWW-DELL. You can also obtain the corresponding source files from the following website: www.dell.com/oracle.

Index

C

- cabling
 - SAS storage, 22, 25
- cluster
 - fibre channel, 9, 17
- Clusterware
 - error, 74
 - installing, 52
 - node restarts with blue screen, 75
 - preparing disks, 36
 - uninstalling, 67

D

- database disk, 39
- disks
 - database, 39
 - flash recovery, 36
 - voting, 36

E

- EMC
 - Naviagent, 34
 - PowerPath, 8

F

- fibre channel
 - cluster configuration, 9
 - Dell|EMC, 18
 - SAN-attached, 17
 - setting up, 17
- flash recovery
 - area, 39
 - disks, 36

H

- hardware
 - connections, 17-18
 - requirements, 9
- help, 81
 - Dell support, 81
 - Oracle support, 82

I

- IP addresses
 - configuring, 32

L

- listener
 - configuring, 49, 58

M

Multi-Path, 35
 driver, 36

N

Naviagent, 34
network
 configuring, 28
NIC
 port assignments, 29

O

OCFS, 39
 creating seed database, 49
 installing Oracle using, 41
OCR
 disk, 36
Oracle
 preparing disks for
 Clusterware, 36
OUI
 running, 67

P

partitions
 creating, 36
patches
 downloading, 48
 installing, 47

patchset
 installing, 56
PowerPath
 installing, 35

S

SAS
 cluster configuration, 9
seed database
 creating, 49
storage
 configuring, 28
 disks unreachable, 79
 SCSI devices do not appear, 80

T

TOE, 30
troubleshooting
 additional information, 71
 blue screen, 77

V

VIPCA
 configuration fails, 81
voting disk, 37
 creating logical drive, 38
 nodes cannot access, 77

W

Windows

 configuring, 11

 installing, 11

